

Syringes

for Chromatographic & Analytical Applications

*Autosampler
Syringes*

*Manual
Syringes*

*Specialty
Syringes*

*Replacement
Parts and
Accessories*

Right to the Point

sigma-aldrich.com/supelco

 **SUPELCO®**

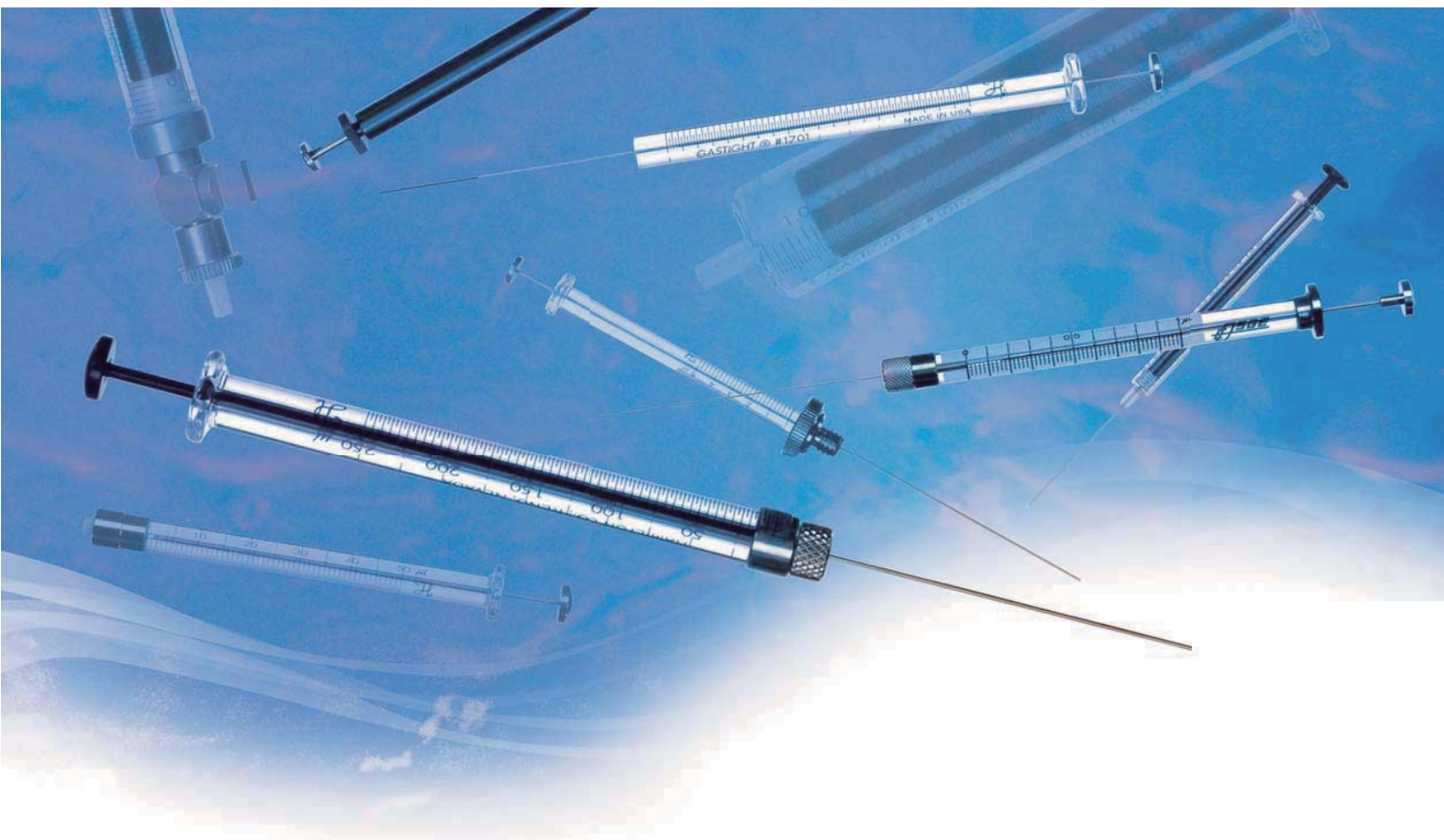

Syringes, Replacement Parts and Accessories

Look to Sigma-Aldrich for High-Quality Syringes for Chromatography and Other Analytical Applications

Like vials and other components that come in contact with the sample, syringes can be a critical component of a successful analysis. The right choice of syringe is vital to ensure proper fit and operation within the instrument, accurate and precise injections, and long functional lifetime. An incorrect or poor quality syringe can damage the instrument and cause downtime. Structurally, syringes must ensure a tight and secure fit in the injection port and withstand repeated injection cycles without bending or breaking. Compositionally, they must be able to withstand chemical and mechanical forces within a defined range. Chemically, they must be inert and not introduce extraneous, interfering compounds into the sample. Syringes also must deliver accurate and precise volumes with no dead volume or carryover between injections.

All Major Syringe Brands

Supelco not only supplies high-quality analytical syringes, we use them! Chemists in our R&D, Applications, and Quality Control departments rely on HPLC, GC, headspace, and purge & trap syringes for exactly the same reasons as you do:

accuracy, precision, ruggedness, and instrument compatibility. The syringes we list in this brochure have been selected for quality and seamless integration with today's analytical instruments. We carry the popular and high-quality Hamilton, SGE and VICI® Precision Sampling analytical gas and liquid syringes and accessories. The selection of brands gives you choices based on the product offering, application relevance, instrument compatibility, and personal preference. We continually work with our customers, suppliers, and instrument manufacturers to make sure our syringe line stays up-to-date. As with all of our products, they are backed by Sigma-Aldrich's commitment to innovation, quality, and service.

Sigma-Aldrich is Dedicated to Complete Customer Satisfaction

Although this catalog contains select syringes, all SGE, Hamilton or VICI Precision Sampling syringe products are available from Supelco. If you want a syringe or accessory that does not appear in this catalog, we will gladly supply it for you. We can also obtain syringes with different terminations, needle styles or lengths. Custom orders follow the same prompt delivery and competitive pricing as our stocked products.

"Accelerating Customers' Success through Leadership in Life Science, High Technology and Service"

Contents

	Page
Technical Information	
Choosing a Syringe	
Guidelines and Factors to Consider	4
Decision Trees	5
Syringe Parameters	
Termination Choices	6
Needle Point Styles	7
Needle Gauges	7
Overview of Hamilton Syringes	
Gas/Liquid Syringes	8
Liquid Syringes	9
Overview of SGE Syringes	
Gas/Liquid Syringes	11
Gas Tight Syringes	12
Overview of Valco VICI Precision Sampling Syringes	
Gas/Liquid Syringes	13
Liquid Syringes	14
Popular Syringes & Replacement Parts	15
Autosampler Syringes (GC and HPLC)	
Agilent	
1090, 1100 (HPLC)	16
7673, 7683 and 6850	16
7670, 7671 and 7672	17
CTC/LEAP	
A200S, GC PAL Autosamplers	18
CombiPAL™, GC Headspace	18
HTS PAL (HPLC)	18
PerkinElmer	
GC AutoSystem™ and Clarus® 500	18
AS100, AS2000 and AS3000	19
Phillips/Unicam	
S8 and 4700	19
Shimadzu	
AOC 9	19
AOC 14, AOC 17, AOC 20	19
Thermo Finnigan	
.	19
Varian	
8000, 8035, 8100, 8200	19

	Page
Manual Syringes	
Gas/Liquid Manual Syringes	
Hamilton	
Gastight®	20
SampleLock™	22
Valco VICI Precision Sampling Syringes	
Series A, C, D, and Magnum	23
SGE	
Gas Tight Syringes	24
Liquid Manual Syringes	
Hamilton	
Microliter™	25
SGE	
Microvolume	27
HPLC Injection Valves	
Waters U6K Loop Injector	
Hamilton 800 Series	28
Rheodyne, Valco VISF-2, Altex and SSI Valves	
Hamilton	28
SGE	28
Multipaks	
Hamilton	29
SGE	29
Special Purpose Syringes	
Hamilton	30
SGE	31
Replacement Parts	
Hamilton	32
SGE	34
Valco VICI Precision Sampling	34
Accessories	
Cleaning Tools	35
Valves	35
Miscellaneous	37
Care and Cleaning of Syringes	38
Ordering Information	39

Trademarks

Altex — Beckman Coulter, Inc.
 AutoSystem, Clarus, PerkinElmer — PerkinElmer Inc.
 Cheminert, Pressure-Lok, VICI — Valco Instruments Co., Inc.
 CombiPAL — CTC Analytics
 Gastight, Hamilton, Microliter, SampleLock — Hamilton Co.
 KEL-F — Minnesota Mining and Manufacturing Co.
 Luer-Lok — Becton, Dickinson & Co.
 Microseal — Merlin Instrument Company
 Rheodyne — Rheodyne, Inc.
 SGE, SuperFlex — SGE International Pty Ltd
 Shimadzu — Shimadzu Corp.
 Varian — Varian Associates Corp.
 Waters — Waters Associates, Inc.



Choosing a Syringe

Guidelines and Factors to Consider

The fact that we've dedicated an entire brochure to syringes testifies to the large number of syringes that are available. Choosing from among them can be confusing. From our experience, here are some guidelines we've put together to help make the choice easier.

1. Are you using an autosampler?

- If yes, then go directly to the section in this brochure that lists the major autosamplers. We've simplified your choice by listing the right syringe for each autosampler. The major difference is the format of the plunger.

2. Are you doing manual HPLC injection using a Rheodyne or Waters U6K valve?

- If yes, then go directly to Page 28. We've chosen the best syringes for these valves.

3. Do you have a preferred manufacturer?

- If yes, then refer to the sections in this brochure that describe the analytical syringes carried by Hamilton, SGE and Valco VICI.

4. The important syringe parameters that you have to choose between include:

- Manufacturer (often a matter of personal preference)
- Volume range
- Termination – the interface between the syringe and its mating connection, usually a needle. Syringe manufacturers have their own nomenclature.
 - Cemented (fixed) – economical, autosamplers, one syringe-one method
 - Luer tip or Luer-Lok™ – syringe filter or pump priming
 - Removable needle – one syringe-many methods
 - Knurled hub
 - SampleLock™ (Hamilton) or Pressure-Lok® (VICI) – collect and store volatile samples
- Needles
 - Point style (styles 2 and 3 are common)
 - Gauge (22, 23, 26 and 23-26 dual taper are common)
 - Length (depends on application, ~2" is common)
- Special features
 - Attachments and other features that increase the ruggedness of the syringe
 - Guides that permit better sample repeatability (e.g. Chaney adapters)
 - Accommodations for extremely small volumes (e.g. SGE's Needle-in-Plunger option)
 - Application-specific features

5. Guiding the selection of syringe parameters are three user-related areas:

- Sample type
- Volume range
- Application

6. Type of sample

- Syringes suitable for both gas and liquid applications typically have a PTFE plunger tip that forms a gas tight fit with the syringe barrel. The PTFE tip scrapes sample from the barrel, like a spatula.
- Syringe for liquid only are manufactured using a hand-fitted plunger and a barrel with tight tolerances for inside diameter.
- For viscous or heterogenous samples, Hamilton Gastight and SGE Gas Tight syringes are recommended to avoid seizing a fitted plunger.

7. Sample volume

- Although syringe designs differ, it is recommended that the smallest injectable volume from a syringe be no less than 20% of its total volume. The smallest dispensing volume should be no less than 10% of the total volume.
- Refer to the sections in this brochure that describe the analytical syringes carried by Hamilton, SGE and Valco VICI. The sections list volume ranges for each syringe model.

8. Application

It is impossible to recommend syringes for all possible analytical applications. Some general guidelines follow.

- Head space sampling
 - Environmental sample collection and storage
 - SampleLock (Hamilton) or Pressure-Lok® (VICI) are ideal
- Extremely small samples (< 1 µL)
 - Choose from several styles, including SGE's Needle-in-Plunger option
- Teaching laboratories or novice users
 - Economical syringes with ruggedness as a design feature
 - SGE SuperFlex™ design
- Multiple, rapid manual injections
 - Syringes with guides and/or reinforced plungers
 - SGE guided plunger or plunger protection syringes
- Field use, dirty samples
 - Removable, replaceable needles

Still can't decide what you need?

Call us at 800-359-3041 (814-359-3041)
or techservice@sial.com

Generalized Decision Trees for Syringe Selection

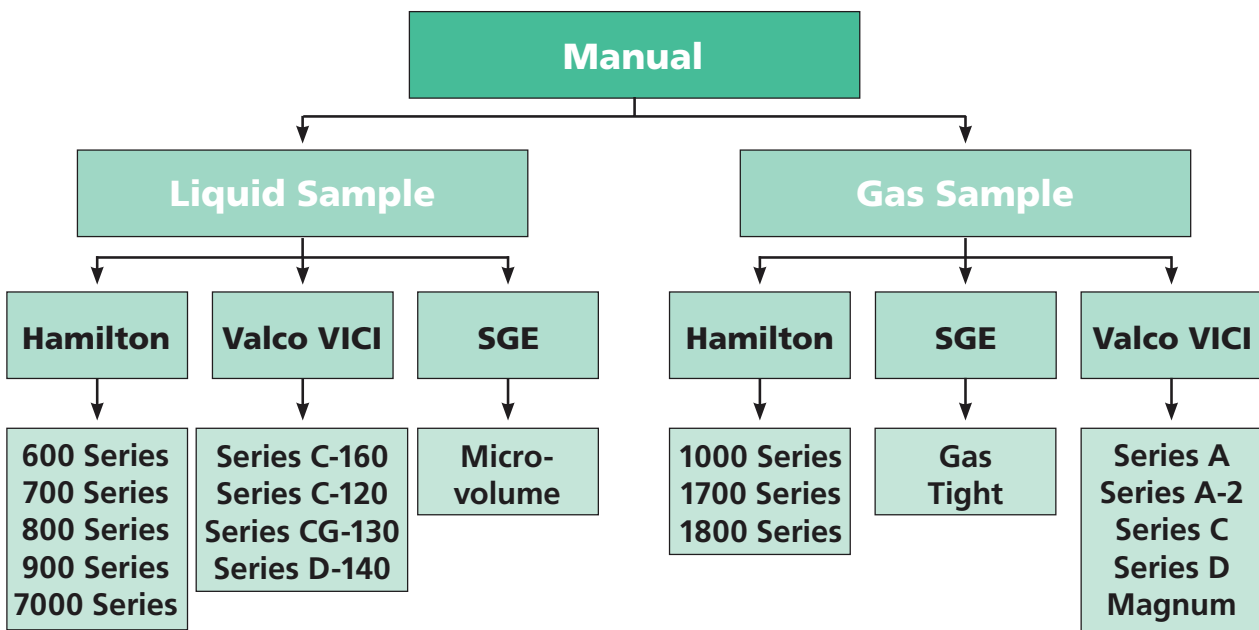
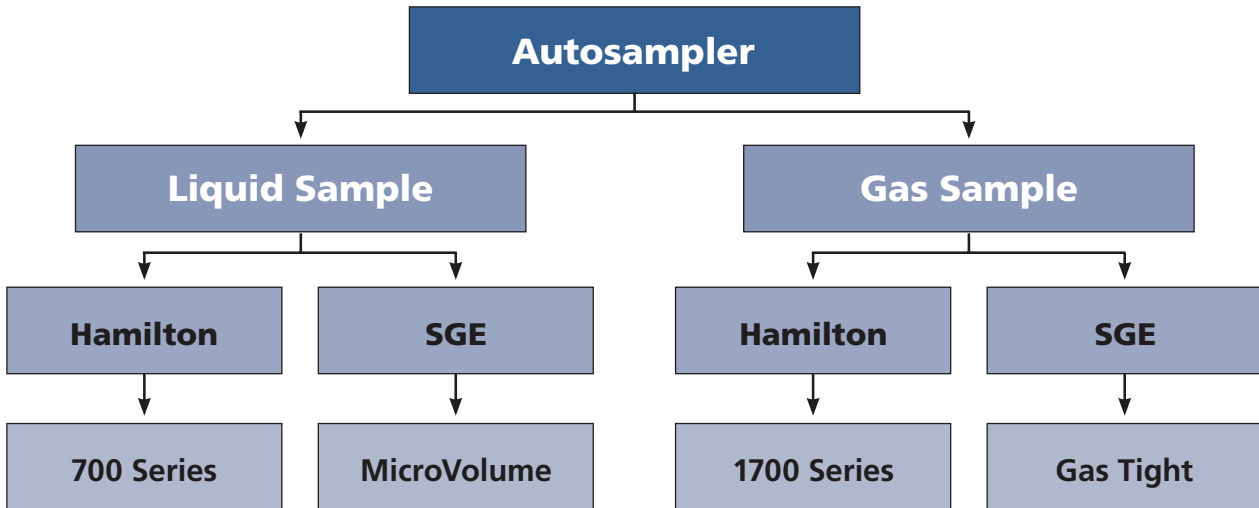

technical service: 800-359-3041 (US and Canada only) / 814-359-3041

ordering: 800-247-6628 (US only) / 814-359-3441



Syringe Parameters

Termination Choices

The termination is the interface, or connection, between the syringe barrel and the needle. The choice depends on the application. Each manufacturer has its own specification nomenclature.

Fixed (cemented) – Economical, reproducible injections, for autosamplers, one syringe-one method, do not heat above 50 °C

Removable needle – One syringe-many methods, simplicity of fixed needle, but needle can be replaced if damaged or clogged, do not heat above 115 °C

Knurled hub – Creates a leak-tight seal that can be retightened to compensate for wear

Luer tip – Easy, fast needle replacement, syringe filter or pump priming, Luer tip is ground glass suitable for mounting chromatographic or PTFE needles, syringes can be autoclaved (without plunger or needle)

Luer-Lok – Security of a locked needle, syringe filter or pump priming, PTFE, male Luer taper with nickel-plated brass locking hub for use with KEL-F® or metal hub needles and universal connectors

Syringe-Valves – Syringe with On-Off valves, head space applications, collect and store volatile samples, examples are SampleLock (Hamilton) or Pressure-Lok (VICI).

Hamilton Termination Nomenclature:

N – Fixed needle, RN – Removable needle, LT – Luer tip, KH – Knurled hub, TLL – PTFE Luer-Lok, WG – Plunger guides which prevent bending the syringe, CH – Chaney adapter, SL – SampleLock

SGE Termination Nomenclature:

F – Fixed needle provides reproducible injects at an economical price, R – Removable needle, LL – Luer-Lok, LT – Luer tip, B – Plunger-in-Needle

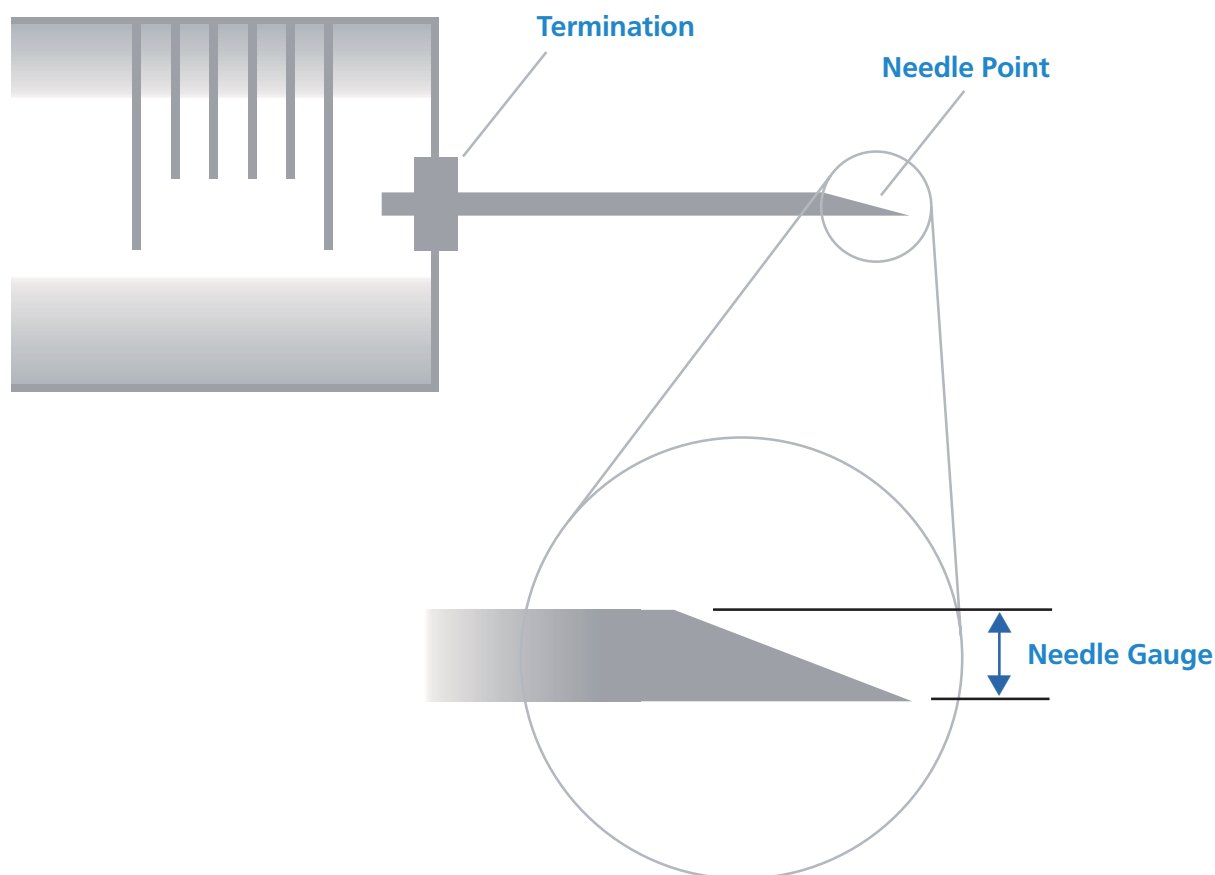





Needle Point Styles

Standard needles are most often point style 2 (sharp point) or 3 (blunt point). For HPLC injections and sample pipetting, the blunt-tip style 3 is preferred. The blunt tip has chamfered and polished edges that eliminate damage to the valve's rotor seal and stator face. This style can also be used for pipetting liquids.

For manual GC injections, a beveled tip, like style 2 is preferred for optimum septum penetration and to prevent septum coring. Also, Hamilton point style AS and SGE cone-tip needles are specially designed for this application. When using an autosampler, consult the instrument manual for the preferred point style.

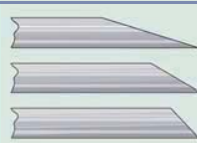
In syringes with point style 5, conical with side port, liquid samples can be filled and dispensed through the hole in the side. Septum damage is minimized by the solid domed tip.

Point Style 2		Sharp, beveled, curved, non-coring needle point recommended for septum penetration. Available gauges: 33-10.
Point Style 3		Blunt needle point for use with HPLC injection valves and for sample pipetting. Available gauges: 33-10
Point Style 4		Standard 12° beveled needle point is recommended for life science applications. Available gauges: 33-10 Special point styles such as 30°, 45°, or any other angle are available upon request.
Point Style 5		Conical needle with side port for penetration of septa, thin-gauged vinyls and plastics without coring. Available gauges: 26-10
Point Style AS		Spherical conical style needle point used on autosampler syringes. The non-coring needle point is recommended for septum penetration. Available gauges: 26-22

Needle Gauges

Gauge is the thickness of the needle. The gauge required depends on the injector. For example, in HPLC applications, Waters instruments use a 25 gauge needle, while Rheodyne, Valco, Altex and SSI valves use 22 gauge.

23 or 23s Single Gauge

- Merlin Microseal™ septa
- Packed column injector ports
- Split/splitless injector ports

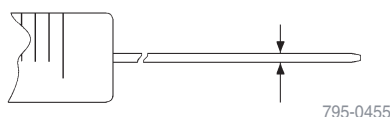

26 or 26s Single Gauge

- Packed column injector ports
- Split/splitless injector ports

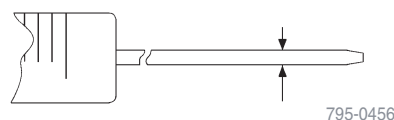

Dual-Gauge 23-26 or 23s-26s Tapered

- Durability of a 23-gauge
- Versatility of a 26-gauge for split/splitless and on-column injection

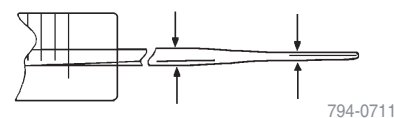

Overview of Hamilton Syringes

Hamilton syringes are accurate to within $\pm 1\%$ of nominal volume with a precision of 1% at 80% of the total volume. Their stainless steel, borosilicate type I glass or PTFE composition ensures a chemically inert fluid path. Hamilton syringes are available in two styles, Gastight and Microliter™, which differ primarily in the design of the plunger. Besides the extensive list of Hamilton syringes presented in this brochure, we can also supply any other Hamilton syringe.

Gas/Liquid Syringes

Delivery Volume: 0.05 μL – 500 μL

Gastight syringes have a precision machined PTFE plunger tip which provides a tight, leak-free seal for both liquids and gases. Replacement plunger assemblies are available for most Gastight syringes.

1000 Series

Luer Tip Cemented Needle (LTN), Luer Tip Special Cemented Needle (LTSN), Luer Tip (LT), Removable Needle (RN), SampleLock (SL), and PTFE Luer-Lok (TLL)

Delivery Volume: 100 μL – 100 mL, Syringe Volumes: 1 mL, 1.25 mL, 2.5 mL, 5 mL, 10 mL, 25 mL, 50 mL, 100 mL

- Mid-volume solution for all liquid and gas handling
- Ideal for manual and automated HPLC injections
- Commonly used in syringe pumps and other liquid handling instrumentation

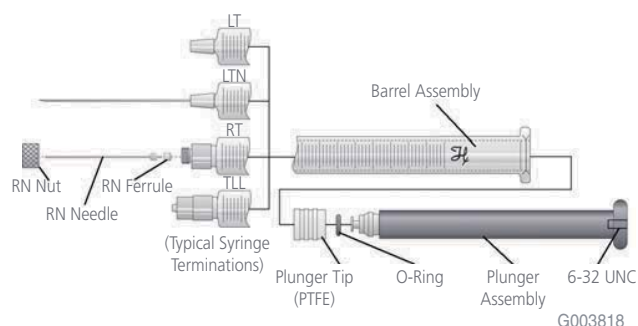

1700 Series

Cemented Needle (N), Special Cemented Needle (SN), Luer Tip Cemented Needle (LTN), Luer Tip Special Cemented Needle (LTSN), Luer Tip (LT), Removable Needle (RN), SampleLock (SL), and PTFE Luer-Lok (TLL)

Delivery Volume: 1 – 500 μL , Syringe Volumes: 10 μL , 25 μL , 50 μL , 100 μL , 250 μL , 500 μL

- Gastight version of the original Hamilton 700 series
- Ideal for low volume gas or liquid handling
- Excellent for manual & automated GC & HPLC injections
- Commonly used in syringe pumps and other liquid handling instrumentation

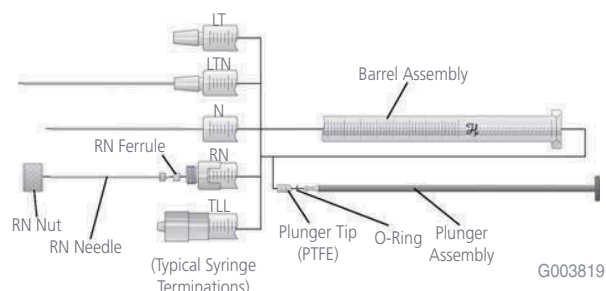

1800 Series

Cemented Needle (N) and Removable Needle (RN)

Delivery Volume: 1 – 250 μL , Syringe Volumes: 10 μL , 25 μL , 50 μL , 100 μL , 250 μL

- Designed to eliminate the possibility of plunger damage
- Same liquid handling capabilities as the 1700 series but the extended plunger eliminates breakage and allows the user some control over the dispensing rate
- Ideal when the plunger of a 1700 syringe may be bent

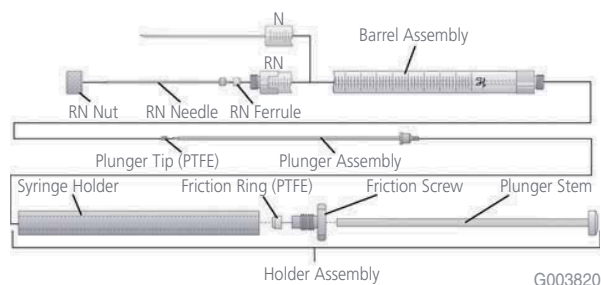

Liquid Syringes

Delivery Volume: 0.05 μL – 500 μL

Microliter syringes feature a stainless steel plunger which is individually hand-fitted to its matching glass barrel. The hand-fitting process is finely controlled to create a liquid-tight seal between the barrel and the plunger. Microliter syringes are for use with liquids and incorporates a stainless steel plunger that is individually fitted to its matching syringe barrel. These syringes are ideal for homogenous samples that are not prone to precipitation or bonding with glass. Plungers for Microliter syringes cannot be interchanged or replaced if damaged. If working with heterogeneous samples, we recommend frequent, diligent cleaning, or using a Gastight syringe instead.

600 Series

Removable Needle (RN)

Delivery Volume: 0.25 μL - 5 μL , Syringe Volumes:
2.5 μL , 5 μL

- Robust design
- Consists of two distinct parts: bottom half of the barrel accurately measures the liquid sample and the top half supports the plunger
- Top section of the plunger is thicker to reduce the risk of bending
- Require half of the standard stroke length making them ideal for one-handed operation
- Plungers and barrels are not interchangeable or replaceable

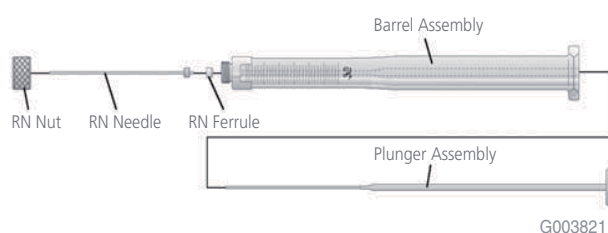

700 Series

Cemented Needle (N), Special Cemented Needle (SN),
Removable Needle (RN) and Luer Tip (LT)

Delivery Volume: 0.5 μL - 500 μL , Syringe Volumes:
5 μL , 10 μL , 25 μL , 50 μL , 100 μL , 250 μL , 500 μL

- The original Hamilton syringe
- Still has wide applicability - industry standard
- Solves general liquid handling requirements
- Plungers and barrels are not interchangeable or replaceable.

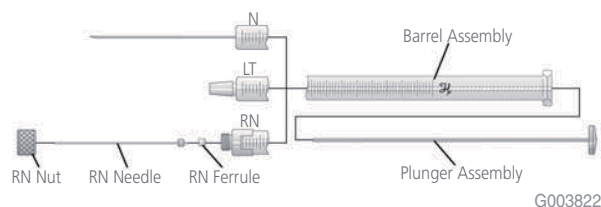

800 Series

Cemented Needle (N), Special Cemented Needle (SN),
and Removable Needle (RN)

Delivery Volume: 0.5 μL - 250 μL , Syringe Volumes:
5 μL , 10 μL , 25 μL , 50 μL , 100 μL , 250 μL

- Intended for applications where the plunger on a 700 series syringe might be bent
- Aluminum syringe holder eliminates plunger damage
- A friction screw at the top of the barrel can be adjusted to give the user some control over dispensing speed and prevent the accidental removal of the plunger.
- Syringe holder can be fitted with different barrel/plunger assemblies to cover a range of volumes
- Excellent for novice users

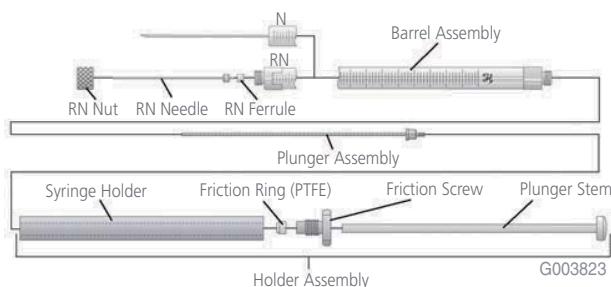

technical service: 800-359-3041 (US and Canada only) / 814-359-3041

ordering: 800-247-6628 (US only) / 814-359-3441

Technical
Information

Right to the Point

900 Series

Cemented Needle (N), Special Cemented Needle (SN), and Removable Needle (RN)

Delivery Volume: 0.5 μL - 10 μL , Syringe Volumes: 5 μL , 10 μL

- Economical version of the 800 series
- Contains no replaceable parts, reducing initial cost
- Perfect when a robust syringe is desired and budget is a consideration

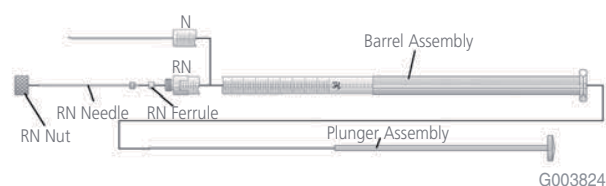
**7000 Series**

Knurled Hub (KH)

Delivery Volume: 0.05 μL - 5 μL , Syringe Volumes: 0.5 μL , 1 μL , 2 μL , 5 μL

- For manual and automated GC and HPLC injections
- Employs a tungsten plunger wire inside the needle to accurately dispense ultra-low volumes
- Ideal for everyday applications that require ultra-small measurements of liquid
- Needle is bored to extremely accurate tolerances to accommodate the plunger wire
- When plunger is inside the needle, the standard dead volume inside the needle is eliminated
- Removable needles, PTFE-tipped replaceable plungers

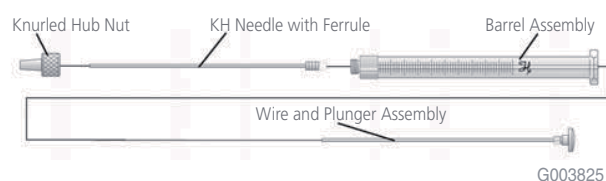
**Syringe Tip: Don't Force it!**

When using Gastight syringes, do not apply excessive force to move the plunger. The PTFE tip on the plunger creates a gas-tight fit against the interior of the glass barrel making these syringes ideal for gas or liquids. Always inspect the syringe barrel for cracks before use. Too much pressure can cause the glass barrel on the syringe to crack.

Various Hamilton Syringes



Overview of SGE Syringes

SGE syringes are designed and tested to meet critical autosampler specifications. The SGE design includes a unique plunger that resists bending and seizing. The needle point style withstands multiple and fast septum injections, making it one of the most trouble-free autosampler syringes available. Both fixed- and removable-style needles are available. SGE syringes are available for GC and LC manual injection and all major brands of HPLC and GC autosamplers. We can also supply any SGE syringe not shown in this brochure.

Gas/Liquid Syringes

SGE Microvolume Syringe

Designers of syringes for microliter sample injections face two interesting problems: extremely fine plungers and proportionally large sample hold-up in the needle. SGE's Plunger-in-Needle feature, which permits extremely small sample injections, and the SuperFlex plunger, which resists bending and kinking, addresses both of these problems. These options are available on some microvolume syringes.

Microvolume syringes also feature:

- Sharp and clear fused graduation
- Extended graduation lines and wide white backing for reduced errors
- Angled needle tip for optimum septum penetration
- Standard plunger is stainless steel individually fitted to its barrel
- **Plunger Protection** – An option on some SGE microvolume syringes. Extended protection tube from top of the flange helps prevent plunger bending during injection
- **Rugged Guided Plunger** – An option on some SGE microvolume syringes. Extended barrel guides the plunger during injection and is suitable for training and student use
 - Robust
 - Rugged (student or tech) use
 - Used by a variety of people



P001077

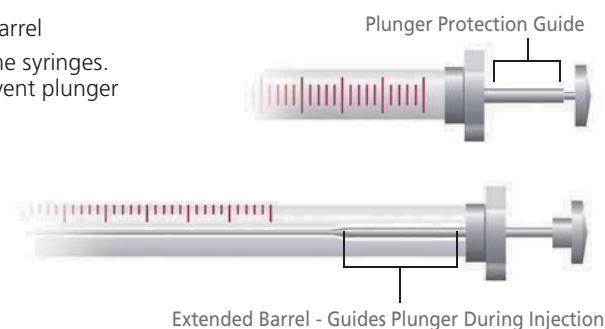

0.1 – 5 μ L Delivery Volume

Plunger-in-Needle Style: 0.5, 1, 5 μ L syringe volumes, fixed needle, cone and bevel tips

Plunger-in-Barrel Style: 5 μ L syringes, fixed and removable needles, cone and bevel tips,

Rugged guided plunger available on 5 μ L plunger-in-barrel syringes, fixed and removable needles, bevel tips

- Inject down to 0.1 μ L with high precision and accuracy
- Perfect for microvolume capillary chromatography injection
- International Standards Traceability

Feature: SuperFlex Plungers

SGE microvolume 10 μ L syringes feature the SuperFlex flexible plunger, which is rugged enough to withstand repeated injections without bending. Made from a titanium/nickel alloy, it is nearly indestructible and ideal for novices.

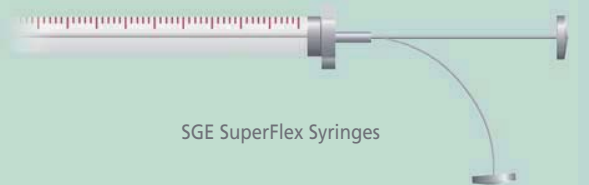

SGE SuperFlex Syringes

E000949

1.5 – 8 μ L Delivery Volume

SuperFlex plunger, 10 μ L syringe volume, fixed and removable needles, cone and bevel tips, SuperFlex plunger

Rugged Guided Plunger: 10 μ L syringes, fixed and removable needles, bevel tips

- Accuracy and reproducibility of $\pm 1\%$
- Metal plunger syringes are ideal for making microvolume injections of 1.5 μ L to 8 μ L

2.5 – 500 μ L Delivery Volume

Syringe Volumes: 25 μ L, 50 μ L, 100 μ L, 250 μ L, 500 μ L. Fixed and removable needles, bevel tips

Feature: Plunger-in-Needle

The Plunger-in-Needle feature of SGE microvolume 0.5, 1 and 5 μ L syringes permits injection down to 0.1 μ L with high precision and accuracy making them perfect for micro capillary chromatography injection.

Cutaway of SGE Plunger-in-Needle Design

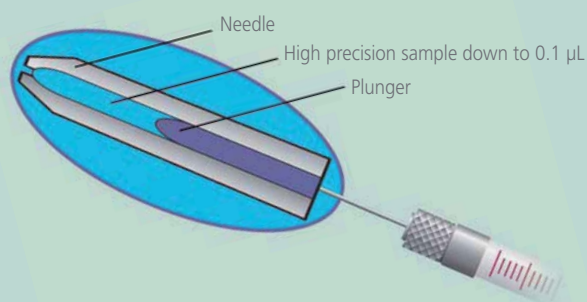

E000948

Gas Tight Syringes

Delivery Volume: 1 μ L – 100 mL

- Constructed from borosilicate glass, PTFE plunger tips and KEL-F or PTFE Luer cones where applicable
- Assembled with an interference fit between plunger tip and barrel to affect the gas sealing properties of the syringe
- Accuracy and reproducibility: $\pm 1\%$

1 μ L to 500 μ L Delivery Volume

Syringe Volumes: 10 μ L, 25 μ L, 50 μ L, 100 μ L, 250 μ L, 500 μ L

Fixed and removable needle, bevel tips

Plungers are interchangeable on these syringes



P001077

0.1 mL to 100 mL Delivery Volume

Syringe Volumes: 1 mL, 2.5 mL, 5 mL, 10 mL (Removable needle)

Syringe Volumes: 1 mL, 2.5 mL, 5 mL, 10 mL, 25 mL, 50 mL, 100 mL (Fixed Luer-Lok needle)

Bevel tips

Replacement plungers available



9100522

Overview of Valco VICI Precision Sampling Syringes

Supelco carries the most popular VICI Precision Sampling syringes from Valco. These syringes have wide applicability for both gases and liquids. The pressurization option is valuable when dealing with transport and storage of volatile samples. We can also supply any Precision Sampling syringe not shown in this brochure.

Gas/Liquid Syringes

Series A

Pressurized storage with built-in rotary valve

Removable needle, bevel, open end

Delivery Volumes: 10 μ L – 10 mL, Syringe Volumes: 100 μ L, 250 μ L, 500 μ L, 1 mL, 2 mL, 5 mL, 10 mL

- Integral sample storage valve - actuated by turning the nosepiece
- Positive rear flange plunger stop - prevents plunger from blowing out of barrel at elevated pressure
- Carrier back-flushing is eliminated - resulting in sharper peaks and better separations
- Modular construction - all components may be quickly disassembled for easy cleaning or replacement
- Leak tight to 250 psi for both liquids and gases
- Has all the standard Pressure-Lok features such as a PTFE plunger tip, PTFE-sealed needle, and ultra-smooth bore



P000433A

Series A-2

Pressurized storage with built-in push-button valve

Removable needle, bevel, open end, also available with Luer needle

Delivery Volumes: 2.5 μ L – 10 mL, Syringe Volumes: 25 μ L, 50 μ L, 100 μ L, 250 μ L, 500 μ L, 1 mL, 2 mL, 5 mL, 10 mL

- Push-button valve - allows sample storage to 250 psi in syringes as small as 25 μ L and instantaneous injection
- Smaller volumes - great for small volatile samples
- Useful with small liquid samples containing low-boiling components which would be lost through evaporation using ordinary syringes
- Positive rear stop (in 250 μ L and larger sizes) prevents plunger blowout at elevated pressures, protecting against sample loss or operator injury
- Has all the standard Pressure-Lok features such as a PTFE plunger tip, PTFE-sealed needle, and ultra-smooth bore



P000433B

Series C

The perfect syringe for everyday use

Removable needle, bevel, open end, also available with Luer needle or with Chaney adapter

Delivery Volumes: 10 μ L – 10 mL, Syringe Volumes: 100 μ L, 250 μ L, 500 μ L, 1 mL, 2 mL, 5 mL, 10 mL

- Positive rear plunger stop
- Low-dead volume removable needle
- Has all the standard Pressure-Lok features such as a PTFE plunger tip, PTFE-sealed needle, and ultra-smooth bore, but without a valve for pressurized sample storage
- Sample storage capability can be added with a Mininert syringe valve
- Optional Chaney adapter offers much lower dead volume than Luer-style connectors



P000433C

Series D

Economically priced gas syringe

Removable needle, bevel, open end

Delivery Volumes: 100 μ L – 2 mL, Syringe Volumes: 1 mL, 2 mL

- Leak-tight to 250 psi
- Pressure-Lok plunger tip
- No dead volume barrel design
- Special low dead volume needle connector for accurate delivery of gas samples



P000433D

Magnum Series**Pressurized storage of large volumes for trace sample isolation**

Removable needle, bevel, open end

Delivery Volume: 2 mL – 500 mL, Syringe Volumes:
20 mL, 50 mL, 100 mL, 250 mL, 500 mL

9130435

- Ideal for collection, trace analysis and sample concentration of environmental contaminants
- A low-dead volume needle is used in this syringe
- A rotary valve allows on-site sampling for later analysis
- Positive displacement capability of the durable PTFE plunger seal permits use in a variety of subsequent procedures involving extraction or concentration of trace components
- The standard termination is a female threaded fitting (1/4-28), which accepts a variety of Cheminert connectors or adapters. Specially formed seals permit leak-tight operation to 30 psi (approximately 2 atmospheres).

Liquid Syringes**Series C-160****VICI basic PTFE plunger-tipped microsyringe**

Fixed and removable needles, bevel, open end

Delivery Volumes: 0.5 μ L – 100 μ L, Syringe Volumes: 5 μ L, 10 μ L, 25 μ L, 50 μ L, 100 μ L

E000819

- Day-in, day-out dependability at an economical price
- Leak-tight to 250 psi - liquids and gases
- PTFE plunger tip is self-lubricating and durable
- PTFE needle seat at rear of needle prevents possible dissolution of needle cement or contamination of sample

Series C-120**Barrel extension for attaching a vacuum bulb or line**

Fixed needle, bevel, open end

Delivery Volumes: 0.5 μ L – 100 μ L, Syringe Volumes: 5 μ L, 10 μ L, 25 μ L, 50 μ L, 100 μ L

E000804

- Leak-tight to 250 psi - liquids and gases
- PTFE plunger tip
- Barrel extension beyond the rear flange – permits attachment of a vacuum bulb or line for easier filling or cleaning
- Standard Pressure-Lok features

Series CG-130**Reinforced plunger to prevent bending**

Fixed and removable needles, bevel, open end

Delivery Volumes: 5 μ L, 10 μ L

P000434C

- Leak-tight to 250 psi - liquids and gases
- Heavy, reinforced plunger within an enlarged plunger guide - eliminates plunger bending
- Lower plunger section confined within the guide section
- Sturdy upper section absorbs the force of a rapid down-stroke

Series D-140**For small (<10 μ L) injections**

Removable needle: size and style vary with syringe size

Delivery Volumes: 1 μ L, 2 μ L, 5 μ L, 10 μ L

P000434D

- Designed for small volume injection into gas chromatographs
- Total sample displacement - the entire sample is contained in the needle
- Positive rear plunger stop - eliminates accidental plunger removal
- Superior alignment - permits repeated reassembly without difficulty or damage
- PTFE seals, needle, plunger, and barrel are all replaceable

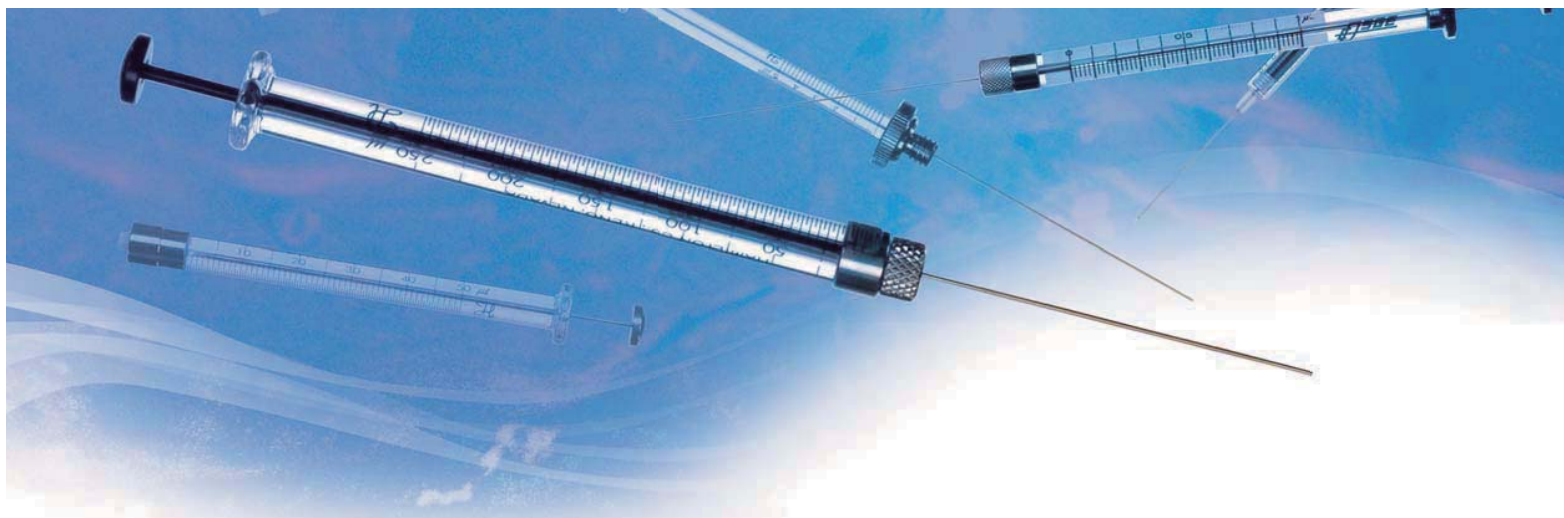

Popular Syringes and Replacement Parts

Description	Supelco Cat. No.	Manufacturer Cat. No.	Page
Hamilton			
Syringes			
Syringe for liquid injection, 701N, pk/6	20779	80366	25
Syringe, 701N, 10 µL	20734	80300	25
Autosampler Syringe for Agilent 7683, pk/6, 701ASN, 10 µL, 0.64 mm O.D.	21317	80390	16
Autosampler Syringe for Agilent 7683, pk/6, 701ASN 10 µL, 23s-26s Needle	24574	80391	16
Syringe, 1010TLL, 10 mL	21000-U	81620	20
Replacement Needles			
800 Series, 25s gauge, 50 mm (1.97 in.), point style 3, pk/6	58399	8648-01	32
22 gauge, 51 mm (2 in.), point style 2, 250 µL-10 mL, pk/6	19137-U	7779-01	32
22 gauge, 51 mm (2 in.), point style 5, 250 µL-10 mL, pk/6	19154-U	7784-02	32
SGE			
Syringes			
Gas Tight, Luer Lock, 10 mL	509507	008960 (10MDR-LL-GT)	24
Microvolume, 50 mm × 0.63 mm, 23 gauge, point style 1, 1 µL	509221	000500 (1BR-5)	27
Microvolume, 70 mm × 0.63 mm, 23 gauge, point style 1, 1 µL	24408	000505 (1BR-7)	27
Plunger-Protected, Fixed Needle, 10 µL	21933-U	002000	27
for Shimadzu Autosamplers, 10 µL	24419	002898 (10R-S-0.63)	19
for Varian 8035, 8100 and 8200 Autosamplers, 10 µL	24421	002924	19
Syringe Valves, Luer-Lok with Luer Tip	509361	031915	36
Replacement Needles			
for 10R-VA8X (for Varian 8035, 8100 & 8200 Autosamplers)	24445	037777 (N10-VA8100H)	34
for Luer-Lok Syringes, 22 gauge, pk/2	26274	039895	34
for Luer-Lok Syringes, 23 gauge, pk/2	26271	39803	34
for Luer-Lok Syringes, 23 gauge, pk/5	26270-U	039802	34
for 10R-VA8 Autosampler Syringe (Varian), 10 µL	21924	031218	19
Valco VICI Precision Sampling			
Syringes			
Series A-2, 25 µL	22268	050023	23
Series A-2, 0.5 mL	22272	050032	23
Series A-2, 1 mL	22273	50033	23
Series A-2, 2 mL	22274	050034	23
Mininert Push Button Valve for use with Hamilton TLL syringes	22285	654051	36
Replacement Needles			
Series A-2, C, D, VICI, side port, taper, pk/3	22289	943052	34
Series A, A-2, C and D, 0.5 mL, pk/2	21950	013932	34
Series A, A-2, C and D, 1 mL, pk/2	21951	013933	34

Autosampler Syringes (GC and HPLC)

The syringe is the interface between the sample and the chromatograph. Rapid and precise sampling requires a tight fit of the syringe in the instrument. An incorrect or poor quality syringe can cause poor results and, more seriously, can damage the instrument. Supelco carries two brands of top-quality syringes, Hamilton and SGE, which serve all major makes and models of GC and HPLC autosamplers that permit syringe replacement.

Manufacturer Model Number	Volume	Needle Length in./mm	Gauge	OD mm	Point Style	Manufacturer Part No.	Pkg. Size	Cat. No.	Replacement Needle Cat. No.
---------------------------	--------	----------------------	-------	-------	-------------	-----------------------	-----------	----------	-----------------------------

Agilent

1090 and 1100 HPLC*

Hamilton

Gastight Syringes - Removable Needle

1702RN	25 µL	2/51	22s	0.72	2	80230	1	20781	19133-U
1725RN	250 µL	2/51	22s	0.72	2	81130	1	20784	19133-U

* Note: These syringes should not use the needle that is supplied with this syringe for the Agilent 1090A.

7673, 7683 and 6850

Hamilton

Modified Microliter Syringes - Removable Needle

7000.5ASRN	0.5 µL	1.71/43	23s	0.64	Cone	86276	1	26214	Inquire
7000.5ASRN	0.5 µL	1.71/43	26s	0.47	Cone	86274	1	26215	26747-U
7001ASRN	1 µL	1.71/43	23s	0.64	Cone	80176	1	26216	Inquire
7001ASRN	1 µL	1.71/43	26s	0.47	Cone	80175	1	26217	Inquire

Microliter Syringes - Fixed Needle

75ASN	5 µL	1.71/43	23s	0.64	Cone	87987	1	21311	---
75ASN	5 µL	1.71/43	26s	0.47	Cone	87988	1	21310-U	---
75ASN	5 µL	1.71/43	23s-26s	0.64-0.47	Cone	87993	1	24570-U	---
75ASN	5 µL 6/pk	1.71/43	23s	0.64	Cone	87990	6	21315	---
75ASN	5 µL 6/pk	1.71/43	26s	0.47	Cone	87989	6	21314	---
75ASN	5 µL 6/pk	1.71/43	23s-26s	0.64-0.47	Cone	87994	6	24571	---
75ASN	5 µL	1.71/43	23s	0.64	Bevel	87991	1	26714	---
75ASN	5 µL	1.71/43	26s	0.47	Bevel	87992	1	26721	---
701ASN	10 µL	1.71/43	23s	0.64	Cone	80387	1	21313	---
701ASN	10 µL	1.71/43	26s	0.47	Cone	80388	1	21312	---
701ASN	10 µL	1.71/43	23s-26s	0.64-0.47	Cone	80393	1	24573	---
701ASN	10 µL 6/pk	1.71/43	23s	0.64	Cone	80390	6	21317	---
701ASN	10 µL 6/pk	1.71/43	26s	0.47	Cone	80389	6	21316	---
701ASN	10 µL 6/pk	1.71/43	23s-26s	0.64-0.47	Cone	80391	6	24574	---
701ASN	10 µL	1.71/43	23s	0.64	Bevel	80398	1	26715	---
701ASN	10 µL	1.71/43	26s	0.47	Bevel	80399	1	26722	---

Microliter Syringes - Removable Needle

75ASRN	5 µL	1.71/43	23s	0.64	Cone	87957	1	21321	21327-U
75ASRN	5 µL	1.71/43	26s	0.47	Cone	87958	1	21320-U	21326
75ASRN	5 µL	1.71/43	23s-26s	0.64-0.47	Cone	87959	1	24572	24582
701ASRN	10 µL	1.71/43	23s	0.64	Cone	80357	1	21323-U	21327-U
701ASRN	10 µL	1.71/43	26s	0.47	Cone	80358	1	21322-U	21326
701ASRN	10 µL	1.71/43	23s-26s	0.64-0.47	Cone	80359	1	24575	24582

Gastight Syringes - Fixed Needle

175	5 µL	1.71/43	23s	0.64	Cone	80074	1	26716	---
175	5 µL 6/pk	1.71/43	23s	0.64	Cone	80090	6	26700-U	---
175	5 µL 6/pk	1.71/43	23s-26s	0.64-0.47	Cone	80092	6	24577	---
1701	10 µL	1.71/43	23s	0.64	Cone	80080	1	26719	---
1701	10 µL	1.71/43	23s-26s	0.64-0.47	Cone	80079	1	24579	---
1701	10 µL 6/pk	1.71/43	23s	0.64	Cone	80094	6	26701	---
1701	10 µL 6/pk	1.71/43	23s-26s	0.64-0.47	Cone	80096	6	24580	---

Gastight Syringes - Removable Needle

175	5 µL	1.71/43	23s-26s	0.64-0.47	Cone	80086	1	24578	24582
1701	10 µL	1.71/43	23s	0.64	Cone	80087	1	21325-U	21327-U
1701	10 µL	1.71/43	26s	0.47	Cone	80088	1	21324	21326
1701	10 µL	1.71/43	23s-26s	0.64-0.47	Cone	80089	1	24581	24582

Manufacturer Model Number	Volume	Needle Length in. / mm	Gauge	OD mm	Point Style	Manufacturer Part No.	Pkg. Size	Cat. No.	Replacement Needle Cat. No.
---------------------------	--------	------------------------	-------	-------	-------------	-----------------------	-----------	----------	-----------------------------

7673, 7683 and 6850 (contd.)

SGE

Fixed Needle

SK-5F-HP-0.47	5 µL	1.65/42	26	0.47	Cone	001804	6	21910	---
5F-HP-0.63	5 µL	1.65/42	23	0.63	Cone	001810	1	21542	---
SK-5F-HP-0.63	5 µL	1.65/42	23	0.63	Cone	001814	6	21911	---
10F-HP-0.47	10 µL	1.65/42	26	0.47	Cone	002800	1	21541	---
SK-10F-HP-0.47	10 µL	1.65/42	26	0.47	Cone	002804	6	21912	---
10F-HP-0.63	10 µL	1.65/42	23	0.63	Cone	002810	1	21543	---
SK-10F-HP-0.63	10 µL	1.65/42	23	0.63	Cone	002814	6	21544	---

Fixed Needle - Dual Gauge

5F-HP-0.63/0.47	5 µL	1.65/42	23-26	0.63/0.47	Cone	001822	6	26887-U	---
10F-HP-0.63/0.47	10 µL	1.65/42	23-26	0.63/0.47	Cone	002822	6	26889-U	---

Gas Tight - Fixed Needle

10R-HP-GT-0.47	10 µL	1.65/42	26	0.47	Cone	002817	1	509671	---
----------------	-------	---------	----	------	------	--------	---	--------	-----

Gas Tight - Fixed Needle, Dual Gauge

10F-HP-GT-0.63/0.47	10 µL	1.65/42	23-26	0.63/0.47	Cone	002826	1	26890-U	---
SK-10F-HP-GT-0.63/0.47	10 µL	1.65/42	23-26	0.63/0.47	Cone	002827	6	26891-U	---
25F-HP-GT-0.63/0.47	25 µL	1.65/42	23-26	0.63/0.47	Cone	003668	1	26892-U	---
50F-HP-GT-0.63/0.47	50 µL	1.65/42	23-26	0.63/0.47	Cone	004668	1	26893-U	---
100F-HP-GT-0.63/0.47	100 µL	1.65/42	23-26	0.63/0.47	Cone	005668	1	26894-U	---

Removable Needle

0.5BR-HP-0.47	0.5 µL	1.65/42	26	0.47	Cone	000400	1	24402	24426
0.5BR-HP-0.63	0.5 µL	1.65/42	23	0.63	Cone	000410	1	24403	24427
5R-HP-0.47	5 µL	1.65/42	26	0.47	Cone	001805	1	23963	23977
5R-HP-0.63	5 µL	1.65/42	23	0.63	Cone	001815	1	23962	---
10R-HP-0.47	10 µL	1.65/42	26	0.47	Cone	002805	1	24417	24440-U
10R-HP-0.63	10 µL	1.65/42	23	0.63	Cone	002815	1	24416	24439
25R-HP-0.63	25 µL	1.65/42	23	0.63	Cone	003865	1	509701	509728

Gas Tight - Removable Needle

10R-HP-GT-0.47	10 µL	1.65/42	26	0.47	Cone	002817	1	509671	24440-U
----------------	-------	---------	----	------	------	--------	---	--------	---------

Removable Needle - Flexible Plunger

10RX-HP-0.47	10 µL	1.65/42	26	0.47	Cone	002844	1	23959	24440-U
10RX-HP-0.63	10 µL	1.65/42	23	0.63	Cone	002845	1	23958	24439

7670, 7671 and 7672

Hamilton

Microliter Syringes - Fixed Needle

75	5 µL	2/51	26s	0.47	Bevel	87900	1	26200-U	---
701	10 µL	2/51	26s	0.47	Bevel	80300	1	20734	---
701	10 µL	2/51	26s	0.47	Bevel	80366	6	20779	---

Microliter Syringes - Removable Needle

701	10 µL	2/51	26s	0.47	Bevel	80338	1	21357	19131-U
-----	-------	------	-----	------	-------	-------	---	-------	---------

Gastight Syringes - Fixed Needle

1701	10 µL	2/51	26s	0.47	Bevel	80000	1	20972	---
------	-------	------	-----	------	-------	-------	---	-------	-----

SGE

Removable Needle

1BR-FV-56	1 µL	2.2/56	23	0.64	Bevel	000587	1	24409	24433
-----------	------	--------	----	------	-------	--------	---	-------	-------

ordering: 800-247-6628 (US only) / 814-359-3441 technical service: 800-359-3041 (US and Canada only) / 814-359-3041

ordering: 800-247-6628 (US only) / 814-359-3441 technical service: 800-359-3041 (US and Canada only) / 814-359-3041

**Autosampler
Syringes**

Right to the Point

Manufacturer Model Number	Volume	Needle Length in./mm	Gauge	OD mm	Point Style	Manufacturer Part No.	Pkg. Size	Cat. No.	Replacement Needle Cat. No.
---------------------------	--------	----------------------	-------	-------	-------------	-----------------------	-----------	----------	-----------------------------

CTC

A200S, GC PAL Autosamplers

Hamilton

Microliter Syringes - Fixed Needle

7701.2N	1.2 µL	2/51	26P	---	Cone	203185	1	28617-U	---
---------	--------	------	-----	-----	------	--------	---	---------	-----

Microliter Syringes - Fixed Needle

75N	5 µL	2/51	26s	0.47	Cone	203189	1	28613-U	---
701N	10 µL	2/51	26s	0.47	Bevel	203072	1	28614-U	---
701N	10 µL	2/51	26s	0.47	Cone	203205	1	28615-U	---

Gastight Syringes - Fixed Needle

1702N	25 µL	2/51	26s	0.47	Cone	203043	1	28649-U	---
1710N	100 µL	2/51	26s	0.47	Cone	203076	1	28651-U	---
1725N	250 µL	2/51	26s	0.47	Cone	203078	1	28652-U	---
1750N	500 µL	2/51	26s	0.47	Cone	203080	1	28653-U	---

CombiPAL Autosamplers, GC Headspace

Hamilton

Gastight Syringes - Fixed Needle

1000LTN	1 mL	2.2/56	23	0.64	Cone tip, Side-port	203082	1	28621-U	---
1001LTN	1 mL	2.2/56	26	0.47	Cone tip, Side-port	203141	1	28622-U	---
1002LTN	2.5 mL	2.2/56	23	0.64	Cone tip, Side-port	203084	1	28626-U	---
1002LTN	2.5 mL	2.2/56	26	0.47	Cone tip, Side-port	203181	1	28627-U	---
1005LTN	5 mL	2.2/56	23	0.64	Cone tip, Side-port	203086	1	28628-U	---
1005LTN	5 mL	2.2/56	26	0.47	Cone tip, Side-port	203182	1	28629-U	---

HTS PAL Autosamplers, HPLC Sampling*

Hamilton

Microliter Syringes - Fixed Needle

701N	10 µL	2/51	22s	0.72	Blunt	203073	1	28618-U	---
------	-------	------	-----	------	-------	--------	---	---------	-----

Gastight Syringes - Fixed Needle

1701N	10 µL	2/51	22s	0.72	Blunt	203194	1	28632-U	---
1702N	25 µL	2/51	22s	0.72	Blunt	203075	1	28633-U	---
1710N	100 µL	2/51	22s	0.72	Blunt	203077	1	28634-U	---
1710N	100 µL	2/51	22	0.72	Blunt	203235	1	28635-U	---
1725N	250 µL	2/51	22	0.72	Blunt	203079	1	28636-U	---
1001LTN	1 mL	2.2/56	22	0.72	Blunt	203081	1	28637-U	---
1002LTN	2.5 mL	2.2/56	22	0.72	Blunt	203083	1	28638-U	---
1005LTN	5 mL	2.2/56	22	0.72	Blunt	203085	1	28639-U	---

* See replacement parts section for replacement plungers for all CTC syringes.

PerkinElmer

GC Autosystem and Clarus® 500

Hamilton

Microliter Syringes - Fixed Needle

75ASN/PE	5 µL	2.75/70	26s	0.47	Blunt	88040	1	24522	---
75ASN/PE	5 µL	2.75/70	23s	0.64	Blunt	88035	1	24523	---

SGE

Fixed Needle

5F-PE-0.47	5 µL	2.75/70	26	0.47	Cone	001953	1	509736	---
5F-PE-0.63	5 µL	2.75/70	23	0.63	Cone	001954	1	509744	---

Gas Tight Syringes - Fixed Needle

5F-PE-GT-0.47	5 µL	2.75/70	26	0.47	Cone	001955	1	21930-U	---
5F-PE-GT-0.63	5 µL	2.75/70	23	0.63	Cone	001957	1	21929-U	---

Removable Needle (Plunger-in-needle)

0.5BR-PE-0.47	0.5 µL	2.75/70	26	0.47	Cone	000475	1	24406	---
0.5BR-PE-0.63	0.5 µL	2.75/70	23	0.63	Cone	000478	1	24407	24431

AS100, AS2000, AS3000

SGE

Standard Syringes - Fixed Needle

5F-PE-0.47	5 µL	2.75/70	26	0.47	Cone	001953	1	509736	---
5F-PE-0.63	5 µL	2.75/70	23	0.64	Cone	001954	1	509744	---

Manufacturer Model Number	Volume	Needle Length in. / mm	Gauge	OD mm	Point Style	Manufacturer Part No.	Pkg. Size	Cat. No.	Replacement Needle Cat. No.
AS100, AS2000, AS3000 (contd.)									
Standard Syringes - Removable Needle									
0.5BR-PE-0.47	0.5 µL	2.75/70	26	0.47	Cone	000475	1	24406	Inquire
0.5BR-PE-0.63	0.5 µL	2.75/70	23	0.64	Cone	000478	1	24407	24431
Gas Tight Syringes - Fixed Needle									
5F-PE-GT-0.47	5 µL	2.75/70	26	0.47	Cone	001955	1	21930-U	---
5F-PE-GT-0.63	5 µL	2.75/70	23	0.64	Cone	001957	1	21929-U	---

Phillips/Unicam

S8 and 4700 GC Autosampler

SGE

Removable Needle (Plunger-in-Needle)

1BR-7	1 µL	2.75/70	23	0.63	Cone	000505	1	24408	24432
-------	------	---------	----	------	------	--------	---	-------	-------

Shimadzu

AOC9 Autosampler

Hamilton

Microliter Syringe - Removable Needle

701	10 µL	2/51	26s	0.47	Bevel	80330	1	20697	19131-U
-----	-------	------	-----	------	-------	-------	---	-------	---------

SGE

Removable Needle

0.5BR-S(9)-0.47	5 µL	1.97/50	26	0.47	Cone	000435	1	509752	Inquire
0.5BR-S(9)-0.63	10 µL	1.97/50	26	0.47	Cone	002885	1	509760	Inquire

Fixed Needle - Flexible Plunger

10FX	10 µL	1.97/50	26	0.47	Bevel	002130	6	23966	---
------	-------	---------	----	------	-------	--------	---	-------	-----

Removable Needle - Flexible Plunger

10RX	10 µL	1.97/50	26	0.47	Bevel	002180	6	23967	24437
------	-------	---------	----	------	-------	--------	---	-------	-------

AOC 14, AOC 17, and AOC 20 GC Autosamplers

SGE

Removable Needle

10R-S-0.47	10 µL	1.65/42	26	0.47	Cone	002897	1	24418	---
10R-S-0.63	10 µL	1.65/42	23	0.63	Cone	002898	1	24419	24442

Thermo Finnigan Autosamplers

Hamilton

Microliter Syringes - Fixed Needle

701	10 µL	2/51	26s	0.47	Bevel	80300	1	20734	---
701	10 µL	2/51	26s	0.47	Bevel	80366	6	20779	---
701	10 µL	2/51	26s	0.47	Cone tip, Side-port	80339	1	24532	---

Microliter Syringes - Removable Needle

701	10 µL	2/51	26s	0.47	Bevel	80338	1	21357	19131-U
-----	-------	------	-----	------	-------	-------	---	-------	---------

Varian Autosamplers

SGE

Varian 8000 GC Autosamplers - Removable Needle

10R-VA80-11	10 µL	1.97/50	25	0.5	Dome	002926	1	24420-U	24443
-------------	-------	---------	----	-----	------	--------	---	---------	-------

Varian 8035, 8100, and 8200 GC Autosamplers - Removable Needle

1BR-VA8X	1 µL	2/51	26	0.47	Cone	000655	1	24410-U	Inquire
10R-VA8X-11	10 µL	2.09/53	25	0.5	Cone tip, Side-port	002924	1	24421	24445

SGE Replacement Needles and Plungers for Varian Syringes



for Varian 8035	---	2.09/53	25	0.5	Bevel	037776	2	24444	---
for Varian 8035	---	4.13/105	On-Column	0.17	Dome	037778	2	24446	---
for Varian 8100	---	2.09/53	25	0.5	Cone tip, Side-port	037777	1	24445	---
Replacement plunger for Varian 10 µL syringes	---	---	---	---	---	031218	1	21924	---



Gas/Liquid Manual Syringes

Supelco offers Hamilton, SGE and VICI Precision Sampling gas/liquid manual injection syringes. Many different styles are available to meet your specific application requirement.

For more information about a particular syringe model, please refer to pages 8-14.

Manufacturer Model Number	Volume	Needle Length in./mm	Gauge	OD mm	Point Style	Manufacturer Part No.	Pkg. Size	Cat. No.	Replacement Needle Cat. No.	
Hamilton										
Gastight 1000 Series										
Hamilton 1000 Series, Fixed Needle					Hamilton 1000 TLL Series					
										
					P001087					
						P001089				
Removable Needle										
1001RN	1 mL	2/51	22	0.72	Bevel (2)	81330	1	22192-U	19137-U	
1002RN	2.5 mL	2/51	22	0.72	Bevel (2)	81430	1	22193-U	19137-U	
1005RN	5 mL	2/51	22	0.72	Bevel (2)	81530	1	22194-U	19137-U	
1010RN	10 mL	2/51	22s	0.72	Bevel (2)	81630	1	22195	19137-U	
Luer Tip*										
1001LT	1 mL				Luer Tip	81301	1	20720	21746 or 21747	
1001.25LT	1.25 mL				Luer Tip	82001	1	24588	21746 or 21747	
1002LT	2.5 mL				Luer Tip	81401	1	20721	21746 or 21747	
1005LT	5 mL				Luer Tip	81501	1	20722	21746 or 21747	
1010LT	10 mL				Luer Tip	81601	1	20723	21746 or 21747	
Fixed Needle										
Luer Tip										
1001LTN	1 mL	2/51	22	0.72	Bevel (2)	81317	1	20740-U	---	
1001.25LTN	1.25 mL	2/51	22	0.72	Bevel (2)	82017	1	24589	---	
1002LTN	2.5 mL	2/51	22	0.72	Bevel (2)	81417	1	20691	---	
1005LTN	5 mL	2/51	22	0.72	Bevel (2)	81517	1	20692	---	
1010LTN	10 mL	2/51	22	0.72	Bevel (2)	81617	1	20693	---	
1001LTN	1 mL	2/51	22	0.72	Side-Port (5)	81343	1	20709	---	
1002LT	2.5 mL	2/51	22	0.72	Side-Port (5)	81443	1	20710-U	---	
1005LT	5 mL	2/51	22	0.72	Side-Port (5)	81543	1	24590	---	
1010LT	10 mL	2/51	22	0.72	Side-Port (5)	81643	1	24591	---	
Teflon Luer-Lok*										
1001TLL	1 mL				Luer-Lok	81320	1	20997	21746 or 21747	
1002TLL	2.5 mL				Luer-Lok	81420	1	20998	21746 or 21747	
1005TLL	5 mL				Luer-Lok	81520	1	20999	21746 or 21747	
1010TLL	10 mL				Luer-Lok	81620	1	21000-U	21746 or 21747	
1025TLL	25 mL				Luer-Lok	82520	1	20683	21746 or 21747	
1050TLL	50 mL				Luer-Lok	85020	1	20707	21746 or 21747	
1100TLL	100 mL				Luer-Lok	86020	1	21967	21746 or 21747	
With Slots										
1001TLL	1 mL				Luer-Lok	81327	1	26208	21746 or 21747	
1002TLL	2.5 mL				Luer-Lok	81427	1	26209	21746 or 21747	
1005TLL	5 mL				Luer-Lok	81527	1	26210-U	21746 or 21747	
1010TLL	10 mL				Luer-Lok	81627	1	26211-U	21746 or 21747	
1025TLL	25 mL				Luer-Lok	82527	1	26212	21746 or 21747	
1050TLL	50 mL				Luer-Lok	85027	1	26213	21746 or 21747	

*Needle not included. Choose between Cat. No. 21746 (with metal hub) or Cat. No. 21747 (with Kel-F hub).

Syringe Tip: For Samples with Particulate Matter, Use a Gastight Syringe.

A Gastight syringe should be selected when analyzing dirty samples. A Gastight syringe stops particulate matter from getting between the plunger and barrel by effectively wiping the barrel ID during the plunger stroke.

Manufacturer Model Number	Volume	Needle Length in. / mm	Gauge	OD mm	Point Style	Manufacturer Part No.	Pkg. Size	Cat. No.	Replacement Needle Cat. No.
---------------------------	--------	------------------------	-------	-------	-------------	-----------------------	-----------	----------	-----------------------------

Gastight 1700 Series

Hamilton 1700-RN Series, Removable Needle



P001092

Hamilton 1700-N Series, Fixed Needle



P001082

Hamilton 1700-LT Series, Luer Tip



P001084

Hamilton 1700 TLL Series, PTFE Luer-Lok



P001081

Hamilton 1700 TLL Series, PTFE Luer-Lok, with slots



P001083

Fixed Needle

1701N	10 µL	2/51	26s	0.47	Bevel (2)	80000	1	20972	---
1702N	25 µL	2/51	22s	0.72	Bevel (2)	80200	1	20973	---
1705N	50 µL	2/51	22s	0.72	Bevel (2)	80900	1	20687	---
1710N	100 µL	2/51	22s	0.72	Bevel (2)	81000	1	20688	---
1725N	250 µL	2/51	22s	0.72	Bevel (2)	81100	1	20689	---
1750N	500 µL	2/51	22	0.72	Side-Port (5)	81243	1	20708	---

Luer Tip

1750LTN	500 µL	2/51	22	0.72	Bevel (2)	81217	1	20690-U	---
---------	--------	------	----	------	-----------	-------	---	---------	-----

With Chaney Adapter
1701NCH

Removable Needle

1701RN	10 µL	2/51	26s	0.47	Bevel (2)	80030	1	20780-U	19131-U
1702RN	25 µL	2/51	22s	0.72	Bevel (2)	80230	1	20781	19133-U
1705RN	50 µL	2/51	22s	0.72	Bevel (2)	80930	1	20782	19133-U
1710RN	100 µL	2/51	22s	0.72	Bevel (2)	81030	1	20783	19133-U
1725RN	250 µL	2/51	22s	0.72	Bevel (2)	81130	1	20784	19136-U
1750RN	500 µL	2/51	22	0.72	Bevel (2)	81230	1	20785-U	19137-U

For Rheodyne, Valco VISF-2, Altex and SSI Injection Valves

1701RNR	10 µL	2/51	22s	0.72	Blunt (3)	80065	1	20885	19139-U
1702RNR	25 µL	2/51	22s	0.72	Blunt (3)	80265	1	20886	19139-U
1705RNR	50 µL	2/51	22s	0.72	Blunt (3)	80965	1	20887	19139-U
1710RNR	100 µL	2/51	22s	0.72	Blunt (3)	81065	1	20888	19139-U
1725RNR	250 µL	2/51	22	0.72	Blunt (3)	81165	1	20889	19143-U
1750RNR	500 µL	2/51	22	0.72	Blunt (3)	81265	1	20890-U	19143-U

Luer Tip*

1701LT	10 µL	Order needle separately			Luer Tip	80001	1	20976	---
1702LT	25 µL	Order needle separately			Luer Tip	80201	1	20977	---
1705LT	50 µL	Order needle separately			Luer Tip	80901	1	20715	---
1710LT	100 µL	Order needle separately			Luer Tip	81001	1	20716	---
1725LT	250 µL	Order needle separately			Luer Tip	81101	1	20717	---
1750LT	500 µL	Order needle separately			Luer Tip	81201	1	20714	---

Teflon Luer-Lok*

1705TLL	50 µL	Order needle separately			Luer Tip	80920	1	26202	---
1710TLL	100 µL	Order needle separately			Luer Tip	81020	1	26203	---
1725TLL	250 µL	Order needle separately			Luer Tip	81120	1	20915	---
1750TLL	500 µL	Order needle separately			Luer Tip	81220	1	20916	---

Teflon Luer-Lok*, with slots

1705TLL	50 µL	Order needle separately			Luer Tip	80927	1	26204	---
1710TLL	100 µL	Order needle separately			Luer Tip	81027	1	26205	---
1725TLL	250 µL	Order needle separately			Luer Tip	81127	1	26206	---
1750TLL	500 µL	Order needle separately			Luer Tip	81227	1	26207	---

*Needle not included.

Gastight 1800 Series

Hamilton 1000 Series, Fixed Needle



P000417

Hamilton 1000 TLL Series



P001976

Fixed Needle

1801N	10 µL	2/51	26s	0.47	Bevel (2)	84875	1	21390	---
1802N	25 µL	2/51	22s	0.72	Bevel (2)	84878	1	21391	---
1805N	50 µL	2/51	22s	0.72	Bevel (2)	84881	1	21392	---
1810N	100 µL	2/51	22s	0.72	Bevel (2)	84684	1	21393	---
1825N	250 µL	2/51	22s	0.72	Bevel (2)	84887	1	21394	---

Removable Needle

1801RN	10 µL	2/51	26s	0.47	Bevel (2)	84877	1	21395	19131-U
1802RN	25 µL	2/51	22s	0.72	Bevel (2)	84880	1	21396	19133-U
1805RN	50 µL	2/51	22s	0.72	Bevel (2)	84883	1	21397	19133-U
1810RN	100 µL	2/51	22s	0.72	Bevel (2)	84886	1	21398	19133-U
1825RN	250 µL	2/51	22s	0.72	Bevel (2)	84889	1	21399	19133-U



Manufacturer Model Number	Volume	Needle Length in/mm	Gauge	OD mm	Point Style	Manufacturer Part No.	Pkg. Size	Cat. No.	Replacement Needle Cat. No.	Plunger Assembly Cat. No.
---------------------------	--------	---------------------	-------	-------	-------------	-----------------------	-----------	----------	-----------------------------	---------------------------

SampleLock Syringes

- Twist valve locks the sample in the syringe
- Positive rear plunger stop eliminates sample loss and plunger blowout at high pressures (not applicable to 1705 and 1710 models)
- Connects to either male or female Luer fittings
- Internal standards can be added through the valve port into the sample contained in the syringe



P000894

Removable Needle

1705SL**	50 µL	2/51	22s	0.72	Bevel (2)	80956	1	26280-U	19136-U	26152-U
1710SL**	100 µL	2/51	22s	0.72	Bevel (2)	81056	1	26281	19136-U	26154
1725SL	250 µL	2/51	22s	0.72	Bevel (2)	81156	1	26282	19136-U	Inquire
1750SL	500 µL	2/51	22s	0.72	Bevel (2)	81256	1	26283	19137-U	Inquire
1001SL	1.0 mL	2/51	22s	0.72	Bevel (2)	81356	1	26284	19137-U	Inquire
1002SL	2.5 mL	2/51	22s	0.72	Bevel (2)	81456	1	26285	19137-U	Inquire
1005SL	5 mL	2/51	22s	0.72	Bevel (2)	81556	1	26286	19137-U	Inquire
1010SL	10 mL	2/51	22s	0.72	Bevel (2)	81656	1	26287	19137-U	Inquire
1025SL	25 mL	2/51	22s	0.72	Bevel (2)	86326	1	26288	19137-U	Inquire
1050SL	50 mL	2/51	22s	0.72	Bevel (2)	86336	1	26289	19137-U	Inquire
1100SL	100 mL	2/51	22s	0.72	Bevel (2)	86346	1	26290-U	19137-U	Inquire

**Plunger assembly for 1705SL is 26152-U. Plunger assembly for 1710SL is 26154.

Luer Fittings for SampleLock Syringes

Description	Cat. No.
Male Luer/Removable Needle Hub	26292
Male Luer-Lok/Removable Needle Hub	26293

26292 - Accepts female luer

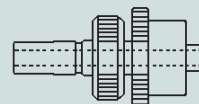

795-0469

26293 - Accepts female luer or female Luer-lok

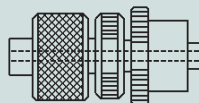

795-0470

Syringe Tip: For Purge & Trap, Use a SampleLock Syringe.

SampleLock syringes are ideal for purge & trap applications because you can easily remove the syringe plunger and load water samples into the syringe barrel. You can add an internal standard or surrogate sample directly to your sample through the twist valve with a 10 µL syringe. Or, you can connect the sample syringe directly to the purge and trap valve via the integral male luer fitting.

Manufacturer Model Number	Volume	Needle Length in./mm	Gauge	OD mm	Point Style	Manufacturer Part No.	Pkg. Size	Cat. No.	Replacement Needle Cat. No.
---------------------------	--------	----------------------	-------	-------	-------------	-----------------------	-----------	----------	-----------------------------

Valco VICI Precision Sampling Syringes

Series A, C, D, and Magnum



Removable Needle

Series A	0.1 mL	2.25/57	0.029	0.012	Bevel (2)	010025	1	22261	20996
Series A	0.25 mL	2.25/57	0.029	0.012	Bevel (2)	010031	1	22262	20996
Series A	0.5 mL	2.25/57	0.029	0.012	Bevel (2)	010032	1	22263	20996
Series A	1 mL	2.25/57	0.029	0.012	Bevel (2)	010033	1	22264	20996
Series A	2 mL	2.25/57	0.029	0.012	Bevel (2)	010034	1	22265	20996
Series A	5 mL	2.25/57	0.029	0.012	Bevel (2)	010035	1	22266	20996
Series A	10 mL	2.25/57	0.029	0.012	Bevel (2)	010036	1	22267	20996

Note: Replacement needle is available with side port to fit the above. Order catalog number 22288.

Series A-2	25 µL	2/51	0.028	0.005	Bevel (2)	050023	1	22268	22298-U
Series A-2	50 µL	2/51	0.028	0.005	Bevel (2)	050024	1	22269-U	22298-U
Series A-2	100 µL	2/51	0.028	0.005	Bevel (2)	050025	1	22270-U	22298-U
Series A-2	250 µL	2/51	0.029	0.012	Bevel (2)	050031	1	22271	22299
Series A-2	500 µL	2/51	0.029	0.012	Bevel (2)	050032	1	22272	22299
Series A-2	1 mL	2/51	0.029	0.012	Bevel (2)	050033	1	22273	22299
Series A-2	2 mL	2/51	0.029	0.012	Bevel (2)	050034	1	22274	22299
Series A-2	5 mL	2/51	0.029	0.012	Bevel (2)	050035	1	22275	22299
Series A-2	10 mL	2/51	0.029	0.012	Bevel (2)	050036	1	22276	22299

Note: Replacement needle is available with side port to fit the 250 µL-10 mL. Order catalog number 22289.

Series C	0.1 mL	2/51	0.029	0.012	Bevel (2)	030025	1	22277	22299
Series C	1 mL	2/51	0.029	0.012	Bevel (2)	030033	1	22280	22299
Series C	2 mL	2/51	0.029	0.012	Bevel (2)	030034	1	22281	22299
Series C	5 mL	2/51	0.029	0.012	Bevel (2)	030035	1	22282	22299
Series C-120	5 µL	2/51	0.019	0.005	Bevel (2)	120021	1	20960-U	---
Series C-120	10 µL	2/51	0.019	0.005	Bevel (2)	120022	1	20961	---
Series C-120	25 µL	2/51	0.019	0.005	Bevel (2)	120023	1	20962	---
Series C-120	100 µL	2/51	0.019	0.005	Bevel (2)	120025	1	20964	---
Series CG-130	5 µL	2.25/57	0.019	0.005	Bevel (2)	130221	1	20956-U	20949
Series CG-130	10 µL	2.25/57	0.019	0.005	Bevel (2)	130222	1	20957-U	20949
Series D	2 mL	2/51	0.029	0.012	Bevel (2)	040034	1	22295	22299
Series D-140	0-2 mL	2.5/57	0.019	0.008	Blunt (3)	140012	1	20985	Inquire
Magnum	50 mL	2/51	0.035	0.023	Bevel (2)	060039	1	21735	21740-U
Magnum	100 mL	2/51	0.035	0.023	Bevel (2)	060040	1	21736	21740-U
Magnum	500 mL	2/51	0.035	0.023	Bevel (2)	060042	1	21738	21740-U

Fixed Needle

Series C-160	10 µL	2/51	0.019	0.005	Bevel (2)	160022	1	20950-U	---
Series C-160	10 µL	2/51	0.019	0.005	Bevel (2)	821012	6	22213	---
Series C-160	25 µL	2/51	0.019	0.005	Bevel (2)	160023	1	20951-U	---
Series C-160	50 µL	2/51	0.019	0.005	Bevel (2)	160024	1	20952-U	---
Series C-160	100 µL	2/51	0.019	0.005	Bevel (2)	160025	1	20953	---
Series CG-130	5 µL	2/51	0.019	0.005	Bevel (2)	130021	1	20954	---
Series CG-130	10 µL	2/51	0.019	0.005	Bevel (2)	130022	1	20955-U	---

Note: Mininert syringe valves are available for Series C and D syringes to store samples at up to 250 psi. The valve body is all PTFE with a stainless steel stem. Order catalog number 22284. Mininert syringe valves are available for Luer-tip syringes from any manufacture and accept traditional Luer needles. Order catalog number 22285.

ordering: 800-247-6628 (US only) / 814-359-3441 technical service: 800-359-3041 (US and Canada only) / 814-359-3041

Manual Syringes



Right to the Point

sigma-aldrich.com/syringes

Manufacturer Model Number	Volume	Needle Length in./mm	Gauge	OD mm	Point Style	Manufacturer Part No.	Pkg. Size	Cat. No.	Replacement Needle Cat. No.
---------------------------	--------	----------------------	-------	-------	-------------	-----------------------	-----------	----------	-----------------------------

SGE

Gas Tight Syringes



9100523

Fixed Needle

10F-GT	10 µL	1.97/50	26	0.47	Bevel (2)	002200	1	26256	---
25F-GT	25 µL	1.97/50	26	0.50	Bevel (2)	003200	1	26257	---
50F-GT	50 µL	1.97/50	25	0.50	Bevel (2)	004200	1	26258-U	---
100F-GT	100 µL	1.97/50	25	0.50	Bevel (2)	005200	1	26259	---
250F-GT	250 µL	1.97/50	25	0.50	Bevel (2)	006200	1	26260-U	---
500F-GT	500 µL	1.97/50	25	0.50	Bevel (2)	007200	1	26261	---

Removable Needle

10R-GT	10 µL	1.97/50	26	0.47	Bevel (2)	002250	1	26237	24437
25R-GT	25 µL	2.75/70	25	0.50	Bevel (2)	003250	1	26262	24447
50R-GT	50 µL	1.97/50	25	0.50	Bevel (2)	004250	1	26263	24447
100R-GT	100 µL	1.97/50	25	0.50	Bevel (2)	005250	1	26264	24447
250R-GT	250 µL	1.97/50	25	0.50	Bevel (2)	006250	1	26265	24447
500R-GT	500 µL	1.97/50	25	0.50	Bevel (2)	007250	1	26266	24447
1MR-GT	1 mL	1.97/50	23	0.63	Bevel (2)	008100	1	509388	Inquire
2.5MDR-GT	2.5 mL	1.97/50	23	0.63	Bevel (2)	008500	1	509396	Inquire
5MDR-GT	5 mL	1.97/50	23	0.63	Bevel (2)	008700	1	509418	Inquire
10MDR-GT	10 mL	1.97/50	23	0.63	Bevel (2)	008900	1	509426	Inquire

Fixed Luer-Lok*

1MDF-LL-GT	1 mL		Order needle separately		---	008025	1	21964	---
2.5MDF-LL-GT	2.5 mL		Order needle separately		---	008425	1	509493	---

Removable Luer-Lok*

5MDR-LL-GT	5 mL		Order needle separately		---	008760	1	21965-U	---
10MDR-LL-GT	10 mL		Order needle separately		---	008960	1	509507	---
25MDR-LL-GT	25 mL		Order needle separately		---	009462	1	509515	---
50MAX-LL-GT	50 mL		Order needle separately		---	009660	1	21532	---
100MR-LL-GT	100 mL		Order needle separately		---	009760	1	21533	---

*Needle not included.

SGE Luer-Lok Needles for SGE Gas Tight Syringes

Needle Length in./mm	Gauge	OD mm	Point Style	Manufacturer Part No.	Pkg. Size	Cat. No.	Replacement Needle Cat. No.
1.97/50	23	0.63	Bevel (2)	039802	5	---	26270-U
1.97/50	23	0.63	Side hole/dome	039803	2	---	26271
2/51	22	0.71	Blunt (3)	039895	2	---	26274
2.75/70	23	0.63	Bevel (2)	039807	5	---	26272
4.53/115	23	0.63	Bevel (2)	039811	5	---	26273-U





Syringe Tip: Syringe Certification - Calibration Services

SGE and Hamilton Company offer calibration services for laboratories involved in GLP, ISO, GMP, ANSI, or National Standards Protocol. This syringe certificate satisfies protocol requirements for syringes and provides the traceability back to N.I.S.T. (National Institute of Standards and Technology). If you are interested in a calibration syringe, simply contact our Technical Service Department who will begin the process for you.

Liquid Manual Syringes

Supelco offers Hamilton and SGE liquid manual injection syringes. Many different styles are available to meet your specific application requirement.

For more information about a particular syringe model, please consult the Overview sections in the beginning of this brochure.

Manufacturer Model Number	Volume	Needle Length in./mm	Gauge	OD mm	Point Style	Manufacturer Part No.	Pkg. Size	Cat. No.	Replacement Needle Cat. No.
Hamilton									
Microliter 600 Series									
Removable Needle 									
Removable Needle									
62RNR	2.5 µL	2/51	22s	0.72	Blunt (3)	87942	1	26702	E000829..
62RRR	5 µL	2/51	22s	0.72	Blunt (3)	87943	1	26703	---
Microliter 700 Series									
Fixed Tip Needle  9940302									
Retractable Needle  P001080									
Luer Tip Needle  P001085									
Fixed Needle									
75N	5 µL	2/51	26s	0.47	Bevel (2)	87900	1	26200-U	---
701N	10 µL	2/51	26s	0.47	Bevel (2)	80300	1	20734	---
701N	10 µL	2/51	26s	0.47	Bevel (2)	80366	6	20779	---
702N	25 µL	2/51	22s	0.72	Bevel (2)	80400	1	20735	---
705N	50 µL	2/51	22s	0.72	Bevel (2)	80500	1	20736	---
710N	100 µL	2/51	22s	0.72	Bevel (2)	80600	1	20737	---
725N	250 µL	2/51	22s	0.72	Bevel (2)	80700	1	20738	---
750N	500 µL	2/51	22	0.72	Bevel (2)	80800	1	20739	---
Special Needle									
701SN	10 µL	2/51	26s	0.47	Blunt (3)	80383	1	20682	---
701SN	10 µL	3/76	26s	0.47	Bevel (2)	80384	1	21572	---
701SN	10 µL	4/101	26s	0.47	Bevel (2)	80382	1	20693	---
701SN	10 µL	6/152	26s	0.47	Bevel (2)	80385	1	21574	---
For Rheodyne Injectors									
701SNR	10 µL	2/51	22s	0.72	Blunt (3)	80365	1	58380-U	---
702SNR	25 µL	2/51	22s	0.72	Blunt (3)	80465	1	58381	---
705SNR	50 µL	2/51	22s	0.72	Blunt (3)	80565	1	58382	---
710SNR	100 µL	2/51	22s	0.72	Blunt (3)	80665	1	58383	---
725SNR	250 µL	2/51	22	0.72	Blunt (3)	80765	1	58384	---
750SNR	500 µL	2/51	22	0.72	Blunt (3)	80865	1	26222-U	---
For Merlin Microseal, Manual Injection									
701SN	10 µL	2/51	23s	0.64	Cone (1)	80395	1	26228	---
With Guide									
701NWWG	10 µL	2/51	26s	0.47	Bevel (2)	80307	1	20753	---
702NWWG	25 µL	2/51	22s	0.72	Bevel (2)	80407	1	20754	---
With Chaney Adapter									
701NCH	10 µL	2/51	26s	0.47	Bevel (2)	80304	1	20747	---
710NCH	100 µL	2/51	22s	0.72	Bevel (2)	80605	1	24541-U	---
Removable Needle									
75RN	5 µL	2/51	26s	0.47	Bevel (2)	87930	1	20919	19131-U
701RN	10 µL	2/51	26s	0.47	Bevel (2)	80330	1	20697	19131-U
701RN	10 µL	2/51	26s	0.47	Bevel (2)	80336	6	20793	19131-U
702RN	25 µL	2/51	22s	0.72	Bevel (2)	80430	1	20787	19133-U
705RN	50 µL	2/51	22s	0.72	Bevel (2)	80530	1	20788	19133-U
710RN	100 µL	2/51	22s	0.72	Bevel (2)	80630	1	20790-U	19133-U
725RN	250 µL	2/51	22s	0.72	Bevel (2)	80730	1	24538-U	19136-U
750RN	500 µL	2/51	22	0.72	Bevel (2)	80830	1	24539	19137-U
With Guide									
701RNWWG	10 µL	2/51	26s	0.47	Bevel (2)	80337	1	20698	19131-U
With Chaney Adapter									
701RNCH	10 µL	2/51	26s	0.47	Bevel (2)	80334	1	20699	19131-U
Luer Tip									
701LT	10 µL		Order needle separately		---	80301	1	24530	---
702LT	25 µL		Order needle separately		---	80401	1	24531	---
705LT	50 µL		Order needle separately		---	80501	1	20701	---
710LT	100 µL		Order needle separately		---	80601	1	20702	---
725LT	250 µL		Order needle separately		---	80701	1	20703	---

technical service: 800-359-3041 (US and Canada only) / 814-359-3041

ordering: 800-247-6628 (US only) / 814-359-3441

Manual Syringes

Right to the Point

Manufacturer Model Number	Volume	Needle Length in./mm	Gauge	OD mm	Point Style	Manufacturer Part No.	Pkg. Size	Cat. No.	Replacement Needle Cat. No.
---------------------------	--------	----------------------	-------	-------	-------------	-----------------------	-----------	----------	-----------------------------

Microliter 800 Series

Fixed Needle

Replaceable Needle



		P001078				P001079			
Fixed Needle									
85N	5 µL	2/51	26s	0.47	Bevel (2)	84850	1	20835-U	---
801N	10 µL	2/51	26s	0.47	Bevel (2)	84852	1	20795-U	---
802N	25 µL	2/51	22s	0.72	Bevel (2)	84854	1	21492	---
805N	50 µL	2/51	22s	0.72	Bevel (2)	84856	1	24544	---
810N	100 µL	2/51	22s	0.72	Bevel (2)	84858	1	21497-U	---
Removable Needle									
85RN	5 µL	2/51	26s	0.47	Bevel (2)	84851	1	26201	19131-U
801RN	10 µL	2/51	26s	0.47	Bevel (2)	84853	1	20797	19131-U
802RN	25 µL	2/51	22s	0.72	Bevel (2)	84855	1	21493	19133-U
805RN	50 µL	2/51	22s	0.72	Bevel (2)	84857	1	21496	19133-U
810RN	100 µL	2/51	22s	0.72	Bevel (2)	84859	1	21498	19133-U
825RN	250 µL	2/51	22s	0.72	Bevel (2)	84861	1	24546	19136-U
<i>For Waters</i>									
801RNW	10 µL	1.97/50	25s	0.51	Blunt (3)	84815	1	58390-U	5-8398
802RNW	25 µL	1.97/50	25s	0.51	Blunt (3)	84816	1	58391	5-8398
805RNW	50 µL	1.97/50	25s	0.51	Blunt (3)	84817	1	58392	5-8398
810RNW	100 µL	1.97/50	25s	0.51	Blunt (3)	84818	1	58393	5-8398
825RNW	250 µL	1.97/50	25s	0.51	Blunt (3)	84819	1	20693	5-8398

Microliter 900 Series

Fixed and Replaceable Needle



		P000419							
Fixed Needle									
95N	5 µL	2/51	26s	0.47	Bevel (2)	87920	1	20906-U	---
901N	10 µL	2/51	26s	0.47	Bevel (2)	80360	1	20908-U	---
Removable Needle									
95RN	5 µL	2/51	26s	0.47	Bevel (2)	87925	1	20907-U	19131-U
901RN	10 µL	2/51	26s	0.47	Bevel (2)	80370	1	20909-U	19131-U

Microliter 7000 Series

Removable Needle



		P001093							
Removable Needle									
<i>With Knurled Hub</i>									
7000.5	0.5 µL	2.75/70	25	0.51	Bevel (2)	86259	1	22185-U	Inquire
7001	1.0 µL	2.75/70	25s	0.51	Bevel (2)	80135	1	20750	26733
7101	1.0 µL	2.75/70	22s	0.72	Bevel (2)	86211	1	20979	26736
7002	2.0 µL	2.75/70	25	0.51	Bevel (2)	88411	1	20751	26739
7102	2.0 µL	2.75/70	23	0.64	Bevel (2)	88511	1	24592	Inquire
7105	5.0 µL	2.75/70	24	0.57	Bevel (2)	88011	1	20980-U	26745-U
7000.5	0.5 µL	2.75/70	25	0.51	Blunt (3)	86250	1	22184-U	26729
7001	1.0 µL	2.75/70	25s	0.51	Blunt (3)	80100	1	20731	26732-U
7101	1.0 µL	2.75/70	22s	0.72	Blunt (3)	86200	1	20733	26735-U
7002	2.0 µL	2.75/70	25	0.51	Blunt (3)	88400	1	20732	Inquire
7102	2.0 µL	2.75/70	23	0.64	Blunt (3)	88500	1	24593	Inquire
7105	5.0 µL	2.75/70	24	0.57	Blunt (3)	88000	1	20728	Inquire
<i>With Guide</i>									
7000.5	0.5 µL	2.75/70	25	0.51	Blunt (3)	86254	1	24596	26729
7001	1.0 µL	2.75/70	25s	0.51	Blunt (3)	80107	1	20944	26732-U
7101	1.0 µL	2.75/70	22s	0.72	Blunt (3)	86207	1	20726	26735-U
7002	2.0 µL	2.75/70	25	0.51	Blunt (3)	88407	1	20693	Inquire
7102	2.0 µL	2.75/70	23	0.64	Blunt (3)	88507	1	24597	Inquire
7105	5.0 µL	2.75/70	24	0.57	Blunt (3)	88007	1	24598	Inquire
<i>With Chaney Adapter</i>									
7000.5	0.5 µL	2.75/70	25	0.51	Blunt (3)	86252	1	24594	26729
7001	1.0 µL	2.75/70	25s	0.51	Blunt (3)	80104	1	20743	26732-U
7101	1.0 µL	2.75/70	22s	0.72	Blunt (3)	86204	1	24595	26735-U
7105	5.0 µL	2.75/70	24	0.57	Blunt (3)	88004	1	20755	Inquire

Manufacturer Model Number	Volume	Needle Length in. / mm	Gauge	OD mm	Point Style	Manufacturer Part No.	Pkg. Size	Cat. No.	Replacement Needle Cat. No.
---------------------------	--------	------------------------	-------	-------	-------------	-----------------------	-----------	----------	-----------------------------

SGE

Microvolume Plunger Protection

Fixed Needle									
5F	5 µL	1.97/50	26	0.47	Bevel (2)	001000	1	26235-U	---
10F	10 µL	1.97/50	26	0.47	Bevel (2)	002000	1	21933-U	---
SK-10F	10 µL	1.97/50	26	0.47	Bevel (2)	002030	6	21934-U	---
VPK-10F	10 µL	1.97/50	26	0.47	Bevel (2)	002033	10	26239	---
Removable Needle									
5R	5 µL	1.97/50	26	0.47	Bevel (2)	001050	1	26236	24436
10R	10 µL	1.97/50	26	0.47	Bevel (2)	002050	1	24413	24437

Microvolume Flexible Plunger

Fixed Needle									
5FX	5 µL	1.97/50	26	0.47	Bevel (2)	001100	1	23950-U	---
5FX-5C	5 µL	1.97/50	26	0.47	Cone (1)	001105	1	26242	---
10FX	10 µL	1.97/50	26	0.47	Bevel (2)	002100	1	23944	---
SK-10FX	10 µL	1.97/50	26	0.47	Bevel (2)	002130	6	23966	---
10FX-5C	10 µL	1.97/50	26	0.47	Cone (1)	002105	1	26243	---
10FX-5/0.63C	10 µL	1.97/50	23	0.63	Cone (1)	002108	1	26244	---
SK-10FX-5/0.63C	10 µL	1.97/50	23	0.63	Cone (1)	002135	6	26247	---
Removable Needle									
5RX	5 µL	1.97/50	26	0.47	Bevel (2)	001150	1	23953-U	24436
10RX	10 µL	1.97/50	26	0.47	Bevel (2)	002150	1	23947	24437
SK-10RX	10 µL	1.97/50	26	0.47	Bevel (2)	002180	6	23967	24437

Microvolume Standard Plunger

Fixed Needle									
25F	25 µL	1.97/50	25	0.5	Bevel (2)	003000	1	26248	---
50F	50 µL	1.97/50	25	0.5	Bevel (2)	004000	1	26249-U	---
100F	100 µL	1.97/50	25	0.5	Bevel (2)	005000	1	26250-U	---
250F	250 µL	1.97/50	25	0.5		006000	1	26251-U	---
500F	500 µL	1.97/50	25	0.5	Bevel (2)	007000	1	26253-U	---
Removable Needle									
25R	25 µL	1.97/50	25	0.5	Bevel (2)	003050	1	24422-U	24447
50R	50 µL	1.97/50	25	0.5	Bevel (2)	004050	1	26253-U	24447
100R	100 µL	1.97/50	25	0.5	Bevel (2)	005050	1	24423	24447
250R	250 µL	1.97/50	25	0.5	Bevel (2)	006050	1	---	24447
500R	500 µL	1.97/50	25	0.5	Bevel (2)	007050	1	---	24447

Microvolume Plunger-in-Needle Syringe

0.5BNR-5	0.5 µL	1.97/50	23	0.63	Cone (1)	000300	1	24400	24424
0.5BNR-5BV	0.5 µL	1.97/50	23	0.63	Bevel (2)	000301	1	509140	Inquire
0.5BNR-5/0.47	0.5 µL	1.97/50	26	0.47	Cone (1)	000303	1	509167	509175
0.5BR-7	0.5 µL	2.75/70	23	0.63	Cone (1)	000310	1	24401	24425
1BR-5	1 µL	1.97/50	23	0.63	Cone (1)	000500	1	509221	509248
1BR-7	1 µL	2.75/70	23	0.63	Cone (1)	000505	1	24408	24432
1BR-7BV	1 µL	2.75/70	23	0.63	Bevel (2)	000506	1	509256	509264
1BR-7/0.47	1 µL	2.75/70	26	0.47	Cone (1)	000570	1	509272	509280
5BR-7	5 µL	2.75/70	23	0.63	Cone (1)	000802	1	24411	24435
5BR-7BV	5 µL	2.75/70	23	0.63	Bevel (2)	000803	1	509310	Inquire

Microvolume Guided Plunger

Fixed Needle									
5F-GP	5 µL	1.97/50	26	0.47	Bevel (2)	001400	1	21521	---
10F-GP	10 µL	1.97/50	26	0.47	Bevel (2)	002400	1	26240-U	---
Removable Needle									
5R-GP	5 µL	1.97/50	26	0.47	Bevel (2)	001450	1	24412	24436
10R-GP	10 µL	1.97/50	26	0.47	Bevel (2)	002450	1	24414	24437

ordering: 800-247-6628 (us only) / 814-359-3441 technical service: 800-359-3041 (us and Canada only) / 814-359-3041



SUPELCO

HPLC Injection Valves

Manufacturer Model Number	Volume	Needle Length in./mm	Gauge	OD mm	Point Style	Manufacturer Part No.	Pkg. Size	Cat. No.	Replacement Needle Cat. No.
---------------------------	--------	----------------------	-------	-------	-------------	-----------------------	-----------	----------	-----------------------------

Waters U6K Loop Injector

Hamilton 800 Series

Removable Needle

801RNV	10 µL	1.97/50	25s	0.51	Blunt (3)	84815	1	58390-U	58398
802RNV	25 µL	1.97/50	25s	0.51	Blunt (3)	84816	1	58391	58398
805RNV	50 µL	1.97/50	25s	0.51	Blunt (3)	84817	1	58392	58398
810RNV	100 µL	1.97/50	25s	0.51	Blunt (3)	84818	1	58393	58398
825RNV	250 µL	1.97/50	25s	0.51	Blunt (3)	84819	1	58394	58399

Rheodyne, Valco VISF-2, Altex and SSI Valves

Hamilton 1700 Series LC Gastight Syringes

Removable Needle

1701RNR	10 µL	2/51	22s	0.72	Blunt (3)	80065	1	20885	19139-U
1702RNR	25 µL	2/51	22s	0.72	Blunt (3)	80265	1	20886	19139-U
1705RNR	50 µL	2/51	22s	0.72	Blunt (3)	80965	1	20887	19139-U
1710RNR	100 µL	2/51	22s	0.72	Blunt (3)	81065	1	20888	19139-U
1725RNR	250 µL	2/51	22	0.72	Blunt (3)	81165	1	20889	19143-U
1750RNR	500 µL	2/51	22	0.72	Blunt (3)	81265	1	20890-U	19143-U

Hamilton 600 Series

Removable Needle

62RNR	2.5 µL	2/51	22s	0.72	Blunt (3)	87942	1	26702	---
62RNR	5 µL	2/51	22s	0.72	Blunt (3)	87943	1	26703	---

Hamilton 700 Series

Fixed Needle

701SNR	10 µL	2/51	22s	0.72	Blunt (3)	80365	1	58380-U	---
702SNR	25 µL	2/51	22s	0.72	Blunt (3)	80465	1	58381	---
705SNR	50 µL	2/51	22s	0.72	Blunt (3)	80565	1	58382	---
710SNR	100 µL	2/51	22s	0.72	Blunt (3)	80665	1	58383	---
725SNR	250 µL	2/51	22	0.72	Blunt (3)	80765	1	58384	---
750SNR	500 µL	2/51	22	0.72	Blunt (3)	80865	1	26222-U	---

SGE Microvolume Syringes for HPLC Valves



P001077

Fixed Needle

5F-LC	5 µL	2/51	22	0.72	Blunt (3)	001301	1	509779	---
10F-LC	10 µL	2/51	22	0.72	Blunt (3)	002301	1	509787	---
25F-LC	25 µL	2/51	22	0.72	Blunt (3)	003300	1	509795	---
100F-LC	100 µL	2/51	22	0.72	Blunt (3)	005300	1	509817	---
250F-LC	250 µL	2/51	22	0.72	Blunt (3)	006300	1	509825	---
500F-LC	500 µL	2/51	22	0.72	Blunt (3)	007300	1	509833	---

Removable Needle

5R-LC	5 µL	2/51	22	0.72	Blunt (3)	001310	1	509841	23975
10R-LC	10 µL	2/51	22	0.72	Blunt (3)	002310	1	509868	24438-U
25R-LC	25 µL	2/51	22	0.72	Blunt (3)	003310	1	509876	509949
50R-LC	50 µL	2/51	22	0.72	Blunt (3)	004310	1	509884	509949
100R-LC	100 µL	2/51	22	0.72	Blunt (3)	005310	1	509892	509949
250R-LC	250 µL	2/51	22	0.72	Blunt (3)	006310	1	509906	509949
500R-LC	500 µL	2/51	22	0.72	Blunt (3)	007310	1	509914	509949
1MR-LC-GT	1 mL	2/51	22	0.72	Blunt (3)	008105	1	509922	509957
2.5MDR-LC-GT	2.5 mL	2/51	22	0.72	Blunt (3)	008505	1	509930	509957

SGE SuperFlex Syringes for HPLC Valves

Fixed Needle

10FX-LC	10 µL	2/51	22	0.72	Blunt (3)	002300	1	23946	Inquire
---------	-------	------	----	------	-----------	--------	---	-------	---------

Removable Needle

10RX-LC	10 µL	2/51	22	0.72	Blunt (3)	002350	1	23948	24438-U
---------	-------	------	----	------	-----------	--------	---	-------	---------

Multipaks

Manufacturer Model Number	Volume	Needle Length in/mm	Gauge	OD mm	Point Style	Manufacturer Part No.	Pkg. Size	Cat. No.	Replacement Needle Cat. No.
---------------------------	--------	---------------------	-------	-------	-------------	-----------------------	-----------	----------	-----------------------------

Hamilton

Hamilton MULTI-PAKS provide an excellent opportunity to reduce cost, packaging waste, ordering frequency, and delays in replacing damaged or worn syringes.



700 Series Six Packs

Fixed Needle, N (Cemented Needle)									
701N	10 µL	2/51	26s	0.47	Bevel (2)	80366	6	20779	---
RN (Removable Needle)									
701RN	10 µL	2/51	26s	0.47	Bevel (2)	80336	6	20793	19131-U

For Agilent 7673-7683 Autosamplers

Microliter Syringes - Fixed Needle									
75ASN	5 µL	1.71/43	23s	0.64	Cone	87990	6	21315	---
75ASN	5 µL	1.71/43	26s	0.47	Cone	87989	6	21314	---
75ASN	5 µL	1.71/43	23s-26s	0.64-0.47	Cone	87994	6	24571	---
701ASN	10 µL	1.71/43	23s	0.64	Cone	80390	6	21317	---
701ASN	10 µL	1.71/43	26s	0.47	Cone	80389	6	21316	---
701ASN	10 µL	1.71/43	23s-26s	0.64-0.47	Cone	80391	6	24574	---
Gastight Syringes - Fixed Needle									
175	5 µL	1.71/43	23s	0.64	Cone	80090	6	26700-U	---
175	5 µL	1.71/43	23s-26s	0.64-0.47	Cone	80092	6	24577	---
1701	10 µL	1.71/43	23s	0.64	Cone	80094	6	26701	---
1701	10 µL	1.71/43	23s-26s	0.64-0.47	Cone	80096	6	24580	---

800 Series MULTI-PAK™

- Designed for Waters U6K injection valve
- Includes one each of 10, 25, 50, 100, & 250 µL volume syringes
- Contains one handle and a selection of syringe plunger/barrel combinations
- Removable needles (RNW)
- Reinforced plunger
- Needle length: 50 mm (1.97 in.)

800 Series MULTI-PAK	---	---	---	---	---	84890	12	109681-15GT	---
-----------------------------	-----	-----	-----	-----	-----	-------	----	-------------	-----

GC Syringe Pack

Designed for GC capillary use. The most popular Hamilton syringes are available in a convenient package of three different syringes: 701N, 1702N, 7001KH.

GC Syringe Pack	---	---	---	---	---	80380	3	21353	---
701N	10 µL	2/51	26s	0.47	Bevel (2)	80300			
1702N	25 µL	2/51	22s	0.72	Bevel (1)	80200			
7001KH	1 µL	2.75/70	25s	0.51	Blunt (3)	80100			

SGE

Fixed Needle, Plunger Protection									
SK-10F	10 µL	1.97/50	26	0.47	Bevel (2)	002030	6	21934-U	---
VPK-10F	10 µL	1.97/50	26	0.47	Bevel (2)	002030	10	26239	---

Autosampler Syringes for Agilent 7673-7683 Autosamplers

Fixed Needle									
SK-5F-HP-0.47	5 µL	1.65/42	26	0.47	Cone	001804	6	21910	---
SK-5F-HP-0.63	5 µL	1.65/42	23	0.63	Cone	001814	6	21911	---
SK-10F-HP-0.47	10 µL	1.65/42	26	0.47	Cone	002804	6	21912	---
SK-10F-HP-0.63	10 µL	1.65/42	23	0.63	Cone	002814	6	21544	---
Fixed Needle - Dual Gauge									
5F-HP-0.63/0.47	5 µL	1.65/42	23-26	0.63/0.47	Cone	001822	6	26887-U	---
10F-HP-0.63/0.47	10 µL	1.65/42	23-26	0.63/0.47	Cone	002822	6	26889-U	---
Gas Tight - Fixed Needle, Dual Gauge									
SK-10F-HP-GT-0.63/0.47	10 µL	1.65/42	23-26	0.63/0.47	Cone	002827	6	26891-U	---

Special Purpose Syringes

Manufacturer Model Number	Volume	Needle Length in./mm	Gauge	OD mm	Point Style	Manufacturer Part No.	Pkg. Size	Cat. No.
---------------------------	--------	----------------------	-------	-------	-------------	-----------------------	-----------	----------

Hamilton

On-Column Injection Syringe

Stainless steel fixed needle design minimizes dead volume. Use fixed needle syringes with 0.32 mm ID or larger columns.

Use the 701RNFS syringes with liquid samples. PTFE plunger tip makes the 1701RNFS gas tight. Comes with a replaceable fused silica needle. Use these with 0.20 mm ID or larger columns.

The 7000.5KHOC Hamilton sample-in-needle syringe has a 0.5 µL sample capacity. Replaceable stainless steel needle/plunger assembly. Use with 0.25 mm ID or larger columns. This syringe is for liquid samples only.

Fixed Needle

701SN for Agilent	10 µL	4.92/125	32	0.24	Blunt (3)	80308	1	21352
701SN for Carlo Erba	10 µL	2.95/75	32	0.24	Blunt (3)	80351	1	21351

Removable Needle

701RNFS	10 µL	3.94/100	---	0.17	Blunt (3)	87402	1	21359
1701RNFS	10 µL	3.94/100	---	0.17	Blunt (3)	87404	1	21360-U
1801RNFS	10 µL	3.94/100	---	0.17	Blunt (3)	87405	1	26720-U
70005.KHOC	0.5 µL	3.94/100	---	0.23	Blunt (3)	86257	1	21366

Digital Syringe

The only N.I.S.T. traceable, calibrated syringe available. This syringe provides constant injection rate. Volume is dispensed within +/- 0.5% of the syringe volume. The syringe is included as part of the product.



701N	10 µL	2/51	26s	0.47	Bevel (2)	DS80300	1	24452
1701RN	10 µL	2/51	26s	0.47	Bevel (2)	DS80030	1	Z261173-1EA
1702RN	25 µL	2/51	22s	0.72	Bevel (2)	DS80230	1	Z261181-1EA
1750RN	50 µL	2/51	22s	0.72	Bevel (2)	DS81230	1	Z261246-1EA

Constant Rate Syringe

This syringe eliminates injection variability. A spring-driven plunger delivers the sample at the same injection rate, regardless of the operator.

A micrometer dials the desired volume. It has a stainless steel plunger and a PTFE sealing tip. Repeatable and resettable at an accuracy of +/- 1%.



CR700-50	2-50 µL	2/51	22s	0.72	Blunt (3)	84303	1	20713
----------	---------	------	-----	------	-----------	-------	---	-------

Purge and Trap Syringe

This purge and trap version of the SampleLock syringe is designed for analyzing drinking water samples according to US EPA purge and trap concentration techniques (EPA Methods 502.1, 502.2, 503.1, 524.1, and 524.2)



1005SLPT	5 µL	---	---	---	---	81570	1	26294
1005 TLL	5 µL	---	---	---	---	81520	1	20999

TLC Syringe

- PTFE-coated needle tip (3/4") for reproducible sample spotting
- Removable needles



1701TLC	10 µL	2/51	26s	---	TLC	80050	1	Z264385-1EA
1702TLC	25 µL	2/51	22s	---	TLC	80250	1	Z264393-1EA
1705TLC	50 µL	2/51	22	---	TLC	80950	1	Z264407-1EA
1710TLC	100 µL	2/51	22	---	TLC	81050	1	Z264415-1EA

Description	Volume	Needle Length in./mm	Gauge	OD mm	Point Style	Manufacturer Part No.	Pkg. Size	Cat. No.
-------------	--------	-------------------------	-------	----------	----------------	--------------------------	--------------	----------

SGE

Headspace/Soil Gas Syringes

- Fitted with valve and special Luer probe with side hole
- Needle valve in hub allows gas samples to be stored in syringe during transfer to lab
- Recommended for soil headspace extraction
- Probe is removable and replaced with needle during injection in GC



9130300

Gas Tight Headspace syringe	5 mL					008775	1	23984
Replacement probe	—					031571	1	23985
Replacement needles	—					039802	5	26270-U

Pre-Fitted with Removable Needle and Valve



E000951

100 µL	1.97/50	23	0.63	Cone	005279	1	509531
250 µL	1.97/50	23	0.63	Cone	006279	1	509558

Pre-Fitted with Luer-Lok Valve

Needles for this syringe style are found on Page 34.



E000952

1 mL	—	—	—	—	008160	1	509590
5 mL	—	—	—	—	008770	1	509612
10 mL	—	—	—	—	008970	1	509620
25 mL	—	—	—	—	009472	1	509639
100 mL	—	—	—	—	009770	1	509655





Syringe Tip: Routine Syringe Inspection Improves Performance

Syringes should be routinely checked for damage to the barrel and needle. Look for hairline cracks in the barrel. Needles should also be checked for burrs and rough surfaces which may cause tearing and excessive wear on the septum.

ordering: 800-247-6628 (US only) / 814-359-3441 technical service: 800-359-3041 (US and Canada only) / 814-359-3041

Special Purpose
Syringes

Replacement Parts

Description	Volume	Needle Length in./mm	Gauge	OD mm	Point Style	Manufacturer Part No.	Pkg. Size	Cat. No.
Hamilton								
Standard Needle						Metal Hub		
								
								P000407a
KEL-F Hub								P001075
								
Plunger Assembly								P000408a
								
						Syringe Barrel		P000402a
								

Standard Needles for Autosampler Syringes

5-10 µL	1.71/43	23s	0.63	Cone (1)	80457	6	21327-U
5-10 µL	1.71/43	26s	0.47	Cone (1)	80458	6	21326
5-10 µL	1.71/43	23s-26s	0.47-0.63	Cone (1)	80460	6	24582

Standard Needles for Manual Syringes

2.5-100 µL	2/51	26s	0.47	Bevel (2)	7758-02	6	19131-U
2.5-100 µL	2/51	26	0.46	Bevel (2)	7758-04	6	19132-U
2.5-100 µL	2/51	22s	0.72	Bevel (2)	7758-03	6	19133-U
2.5-100 µL	2/51	22	0.72	Bevel (2)	7758-01	6	Z288993-1PAK
2.5-100 µL	3/76	22	0.72	Bevel (2)	7804-01	6	Z118117-6EA
2.5-100 µL	4/101.5	26s	0.47	Bevel (2)	7804-04	6	Z121401-6EA
2.5-100 µL	4/101.5	22	0.72	Bevel (2)	7804-01	6	Z118125-6EA
250-10000 µL	2/51	26s	0.47	Bevel (2)	7779-02	6	19134-U
250-10000 µL	2/51	26	0.46	Bevel (2)	7779-04	6	19135-U
250-10000 µL	2/51	22s	0.72	Bevel (2)	7779-03	6	19136-U
250-10000 µL	2/51	22	0.72	Bevel (2)	7779-01	6	19137-U
250-10000 µL	4/101.5	22	0.72	Bevel (2)	7804-01	6	Z118109-6EA
2.5-100 µL	2/51	26s	0.47	Blunt (3)	7768-01	6	19138-U
2.5-100 µL	1.97/50	25s	0.51	Blunt (3)	80426	6	58398
2.5-100 µL	2/51	22s	0.72	Blunt (3)	7770-01	6	19139-U
250-10000 µL	2/51	26s	0.47	Blunt (3)	7780-01	6	19140-U
250-10000 µL	2/51	26	0.47	Blunt (3)	7780-02	1	19141-U
250-10000 µL	1.97/50	25s	0.51	Blunt (3)	80726	6	58399
250-10000 µL	2/51	22s	0.72	Blunt (3)	7780-03	6	19142-U
250-10000 µL	2/51	22	0.72	Blunt (3)	7780-04	6	19143-U
250-10000 µL	2/51	16	1.52	Blunt (3)	80780	6	26710-U
2.5-100 µL	2/51	26s	0.47	Side-Port (5)	7784-07	6	19144-U
2.5-100 µL	2/51	22s	0.72	Side-Port (5)	7784-05	6	19146-U
250-10000 µL	2/51	26s	0.47	Side-Port (5)	7784-03	6	19147-U
250-10000 µL	2/51	26	0.46	Side-Port (5)	7784-04	6	19148-U
250-10000 µL	4/101.5	26	0.46	Side-Port (5)	7784-04	6	Z121401-6EA
250-10000 µL	2/51	22s	0.72	Side-Port (5)	7784-01	6	19151-U
250-10000 µL	2/51	22	0.72	Side-Port (5)	7784-02	6	19154-U

Description	Volume	Needle Length in./mm	Gauge	OD mm	Point Style	Manufacturer Part No.	Pkg. Size	Cat. No.
Metal Hub and KEL-F Hub Needles for LT and TLL Syringes								
Metal hub		2/51	28	0.36	Bevel (2)	90028	6	20757
Metal hub		2/51	22	0.72	Bevel (2)	90022	6	21746
Metal hub		2/51	22s	0.72	Bevel (2)	90038	6	21748-U
KEL-F hub		2/51	28	0.36	Bevel (2)	90128	6	20756
KEL-F hub		2/51	22s	0.72	Bevel (2)	90138	6	21749
KEL-F hub		2/51	22	0.72	Bevel (2)	90122	6	21747
Metal hub		2/51	22	0.72	Blunt (3)	91022	6	21741
KEL-F hub		2/51	22	0.72	Blunt (3)	90134	6	21744
KEL-F hub		2/51	22s	0.72	Blunt (3)	90534	6	Z288977-1PAK
Metal hub		2/51	22	0.72	Side-Port (5)	90222	6	20803
KEL-F hub		2/51	22s	0.72	Side-Port (5)	90438	6	21743
KEL-F hub		2/51	22	0.72	Side-Port (5)	90422	6	21742-U
Replacement Barrel Assemblies								
85N	5 µL					32150	1	20836
801N	10 µL					32151	1	20837
801RN	10 µL					32129	1	20838-U
1801RN w/o Needle	10 µL					32187	1	21375-U
Gastight 1000 Luer tip Syringe	1.0 mL					1418-01	1	Z26,734-1
	5 mL					10123	1	Z26,736-8
	10 mL					10124	1	Z26,737-6
Plunger Assemblies with Tips for Hamilton Series 1000, 1700, and 1800								
1001 - T-N-LTN-RN-TLL-TLL /slots	1 mL					1359-01	1	26159
1002 - LT-LTN-RN-TLL	2 mL					1360-01	1	26161
1005 - all styles	5 mL					13230	1	26162
1010 - LT-LTN-RN-TLL	10 mL					13231	1	26163
1025 - LT-LTN-RN-TLL	25 mL					13271	1	26164
1701 - all styles	25 µL					13205	1	21343
1702 - C-LT-N-RN	25 µL					1122-01	1	26150
1705 - LT-RN-TLL	50 µL					1162-01	1	26152-U
1710 - C-LT-N-RN-TLL	100 µL					1162-02	1	26154
1725 - LT-N-RN-TLL	250 µL					1162-03	1	26156
1750 - LT-LTN-RN-TLL	500 µL					1169-01	1	26158-U
1801 - N-RN	10 µL					32193	1	27383
1802 - N-RN	25 µL					1160-01	1	26151
1805 - N-RN	50 µL					1161-01	1	26153
1810 - N-RN	100 µL					1161-02	1	26155-U
Replacement Plungers for All CTC Syringes								
1701CTC	10 µL					203229	1	28641-U
1702CTC	25 µL					203045	1	28642-U
1710CTC	100 µL					203096	1	28643-U
1725CTC	250 µL					203098	1	28644-U
1750CTC	500 µL					203061	1	28645-U
1001CTC	1 mL					203255	1	28646-U
1002CTC	2.5 mL					203256	1	28647-U
1005CTC	5 mL					203066	1	28648-U

ordering: 800-247-6628 (US only) / 814-359-3441 technical service: 800-359-3041 (US and Canada only) / 814-359-3041



Description	Volume	Needle Length in./mm	Gauge	OD mm	Point Style	Manufacturer Part No.	Pkg. Size	Cat. No.
SGE								
Standard Needles for Autosampler Syringes								
Agilent Technologies - 7673, 7683 and 6850 ALS								
	0.5 mL	1.65/42	26	0.47	Cone	033708	1	24426
	0.5 mL	1.65/42	23	0.63	Cone	033715	1	24427
	5 mL	1.65/42	26	0.47	Cone	036710	1	23977
	10 mL	1.65/42	26	0.47	Cone	037715	2	24440-U
	10 mL	1.65/42	23	0.63	Cone	037717	2	24439
	25 mL	1.65/42	23	0.63	Cone	038717	2	509728
PerkinElmer - Autosystem and Clarus 500								
	0.5 mL	70	23	0.63	Cone	033765	1	24431
Shimadzu - AOC 14, 17, 20 and 201								
	0.5 mL	1.65/42	23	0.63	Cone	033745	1	24429
	10 mL	1.65/42	23	0.63	Cone	037747	1	24442
Varian - 8000								
	10 mL	1.97/50	25	0.5	Dome	037775	2	24443
Varian - 8035, 8100 and 8200 Series								
	10 mL	1.97/50	26	0.47	Bevel	037777	1	24445
Standard Needles for Manual Syringes								
	5 mL	1.97/50	26	0.47	Cone	036010	2	23980
		1.97/50	26	0.47	Bevel	036110	5	24436
		2/51	22	0.71	Blunt	036250	5	23975
		1.97/50	26	0.47	Side Hole/Dome	036410	2	23981
	10 mL	1.97/50	26	0.47	Cone	037010	2	23982
		1.97/50	23	0.63	Cone	037011	2	26246
		1.97/50	26	0.47	Bevel	037110	5	24437
		2/51	22	0.71	Blunt	037250	5	24438-U
	25-500 mL	1.97/50	25	0.5	Bevel	038110	5	24447
		2/51	22	0.71	Blunt	038250	5	509949
	1-2.5 mL	2/51	22	0.71	Blunt	039250	5	509957
		1.97/50	25	0.5	Blunt	039260	5	23976
Luer-Lok Needles								
		1.97/50	23	0.63	Bevel	039802	2	26270-U
		1.97/50	23	0.63	Side Hole/Dome	039803	2	26271
		2/51	22	0.71	Blunt	039895	2	26274
		2.75/70	23	0.63	Bevel	039807	5	26272
		4.53/115	23	0.63	Bevel	039811	5	26273-U

Replacement Kits for Plunger-in-Needle Microvolume Syringes

6.5 mm OD Barrel								
	0.5 mL	1.97/50	23	0.63	Cone	033010	1	24424
	0.5 mL	1.97/50	26	0.047	Cone	033012	1	509175
8 mm OD Barrel								
	0.5 mL	2.75/70	23	0.63	Cone	033057	1	24425
	1 mL	1.97/50	23	0.63	Cone	034055	1	509248
	1 mL	2.75/70	23	0.63	Cone	034057	1	24432
	1 mL	2.75/70	23	0.63	Bevel	034060	1	509264
	1 mL	2.75/70	26	0.47	Cone	034610	1	509280
	5 mL	2.75/70	23	0.63	Cone	035057	1	24435

Valco VICI Precision Sampling

Replacement Plunger Tips for Series A, A-2, C and D

	500 µL					013932	2	21950
	1 mL					013933	2	21951
	2 mL					013934	2	21952-U
	5 mL					013935	2	21953-U

Description	Volume	Needle Length in./mm	ID (mm/inch)	OD (mm/inch)	Point Style	VICI PIN	Pkg. Size	Cat. No.
Replacement Needles								
Series A								
	100 µL-10 mL	57 (2.25)	0.30 (0.012)	0.74 (0.029)	Bevel, Open End	913050	3	20996
	100 µL-10 mL	57 (2.25)	0.30 (0.012)	0.74 (0.029)	Side Hole, Taper	913050	3	22288
Series A-2, C, D								
	25 µL-100 µL	51 (2.0)	0.13 (0.005)	0.71 (0.028)	Bevel, Open End	943050	3	22298-U
	100 µL-10 mL	51 (2.0)	0.30 (0.012)	0.71 (0.028)	Bevel, Open End	943051	3	22299
	100 µL-10 mL	51 (2.0)	0.30 (0.012)	0.71 (0.028)	Side Hole, Taper	943052	3	22289
Magnum								
	50 mL-500 mL	51 (2.0)	0.58 (0.023)	0.89 (0.035)	Bevel, Open End	953050	3	21740-U

Syringes

sigma-aldrich.com/syringes

Accessories

Cleaning Tools

Syringe Cleaner

Cleans Hamilton syringes and other syringes with needles up to 18 gauge (0.049" OD). Just connect the unit to your water aspirator or other vacuum source, insert the needle through the septum and, in 10-30 seconds, you're ready for a new sample. A combination of heat (250 °C) and vacuum vaporizes and removes contaminating volatiles in a single operation. No liquids are required with Hamilton Series 7000 syringes. For series 700 and other conventional syringes, use a rheostat to lower the temperature (to 50 °C or below) and maintain a flow of solvent through the barrel and needle. Instructions are included.

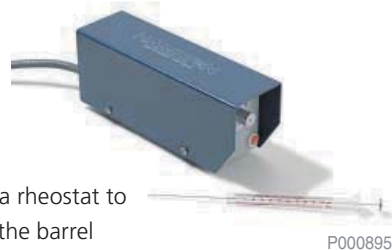

Description	Cat. No.
Hamilton Syringe Cleaner, 120 V	20770-U
Replacement Septa, 5mm, pk. of 100	20712

Needle Cleaning Kit

Formulated specifically for cleaning syringes. Kit includes 70 cc bottle (makes 700 cc of cleaning solution), ten wires in each of five sizes (0.0035" to 0.01207"), and instructions.

Description	Cat. No.
Needle Cleaning Kit	21578
Replacement Syringe Cleaning Solution	20742



Valves

Miniature Two-Way Inlet Valve

This miniature valve is durable, dependable, and easy to use. The inert plastic components (CTFE body and female Luer connectors, PTFE core) will not interact with ultrapure or corrosive fluids. Its size (2 inches³/33 cm³) and weight (1 oz/28 g) make it unobtrusive. A 0.059" internal passage minimizes sample hold-up. When used with a Hamilton PTFE Luer-Lok (TLL) syringe, the valve is particularly useful for transporting gaseous or liquid samples (e.g., environmental analyses of air or water). Use the valve with the Hamilton fittings included, or with any standard ¼" x 28 threaded fittings. This has an aluminum housing, and a stainless steel driver stem. The operating range is from 10 °C to 100 °C at pressures to 100 psi/7 kg/cm². This meets the requirements for US EPA Method 602 for purgeable aromatic compounds.



Description	Tekmar Equivalent	Cat. No.
Valve with Male and Female Connectors		20940
Sample Valve for Tekmar concentrators (order Luer connector separately)	14-0036-050	20971
Male Luer Connector	14-0122-016	20941
Female Luer Connector	14-0216-016	20942-U

technical service: 800-359-3041 (US and Canada only) / 814-359-3041

ordering: 800-247-6628 (US only) / 814-359-3441

Accessories

PTFE Body Two-Way Valve

- Lever-actuated on/off valve for storing and transporting samples
- Hamilton Gastight TLL syringe
- KEL-F hub needles attach to the valve
- Pressure tested to 100 psig; autoclavable
- Bore ID, 0.39"



P000432

Description	Cat. No.
PTFE Body Two-Way Valve	20926

Push Button Valve

This Mininert valve will attach to your syringe and provide sample storing capability. It features push-button operation and an all-PTFE body with a stainless steel miniature valve stem.



P000432

Description	Cat. No.
Push Button Valve for TLL syringes (Hamilton/SGE)	22285
Push Button Valve for VICI Series C and D syringes	22284

SGE Syringe Valve

Description	Volume	Needle Length in./mm	Gauge	OD (mm)	SGE Part No.	Point Style	Pkg. Size	Cat. No.
Push-Pull with Removable Needle								
	25 µL - 2.5 mL	1.97/50	23	0.63	031905	Cone	1	509337
Push-Pull with KEL-F Male Luer-Lok Termination								
	25 µL - 2.5 mL	—	—	—	031907	—	1	509345
Push Button with KEL-F Male Luer-Lok Termination								
	5 mL - 2 L	—	—	—	031910	—	1	509353
Push Button with KEL-F Male Luer-Lok Termination and Luer Tip								
	50 µL - 2 L	—	—	—	031915	—	1	509361

509337 - Push-Pull with Removable 0.63 mm OD x 50 mm Cone Tip Needle



509353 - Push-Button with KEL-F Male Luer-Lok Termination



509345 - Push-Pull with KEL-F Male Luer-Lok Termination



509361 - Push-Button with KEL-F Male Luer-Lok Termination and Luer Tip



P000431

Miscellaneous

Luer Fittings for SampleLock Syringes

Description	Cat. No.
Male Luer/Removable Needle Hub	26292
Male Luer-Lok/Removable Needle Hub	26293

26292 - Accepts female luer

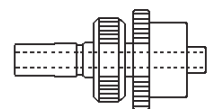

795-0469

26293 - Accepts female luer or female Luer-Lok

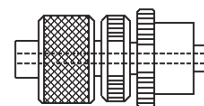

795-0470

Plunger Guide and Chaney Adapter

Plunger guides are recommended for consistent, reproducible injections. Chaney adapters are recommended for sample reproducibility.

Description	Cat. No.
Plunger Guide for 75 and 701 syringes (Hamilton)	20765
Plunger Guide for 702, 705, 750, 1702, 1705, 1710, 1725, 1750, and 7000 syringes	26707
Chaney Adapter for 75, 701, and 1701 syringes	26704
Chaney Adapter for 702, 705, 750, 1702, 1705, 1710, 1725, 1750, and 7000 syringes with round thumb button	21350-U

Plunger Guide



Chaney Adapter

E000827

Repeating Dispenser

This device accurately divides the sample. It discharges 1/50th of the syringe's capacity at each push of the button. This fits all 10 µL-2.5 mL Hamilton syringes. Order the syringe separately.

Description	Cat. No.
Pb600-1	20943



9100192

PTFE Syringe Tubing with KEL-F Luer Hub Assembly

For use with LT or TLL Hamilton syringes and connectors; KEL-F hub maximum temperature is 200 °C. PTFE tubing maximum temperature is 260 °C.

To pass PTFE tubing through a septum, first puncture the septum with a stainless steel (SS) hollow needle and leave the needle in place. Next, thread the PTFE syringe tubing through the center of the hollow needle. Then, withdraw the SS needle and allow the septum to seal around the PTFE tubing.

We recommend using a 14 ga. SS hollow needle to puncture the septum in order to insert 20 ga. PTFE tubing, a 13 ga. SS hollow needle for inserting 18 ga. PTFE tubing, and a 12 ga. SS hollow needle for inserting 16 or 14 ga. PTFE tubing.

PTFE Syringe Tubing

Length (in.)	Size (Gauge)	Cat. No.
12	20	Z117315
	18	Z117323
	16	Z117331
	14	Z117358
24	12	Z117366
	20	Z117374
	18	Z117382
	16	Z117390
	14	Z117404
36	12	Z117412
	20	Z113653
	18	Z113688
	16	Z113696
	14	Z113718
SS Hollow Needles	12	Z113726
	14	Z126756
	13	Z126764
	12	Z126722



Care & Cleaning of Syringes

Syringe Care

Syringes are precision instruments. The care you take in using, handling and storing them will dictate their accuracy, reproducibility and lifetime, and the quality of the resulting chromatogram.

Routinely inspect the syringe for damage including hairline cracks. Discard any syringe with a potentially unsafe barrel. The needle's tip must be free of barbs which will tear the septum, producing particles that will clog the needle, lodge in the injection port and otherwise damage the chromatographic system.

If your syringe contains a PTFE tip, be sure to replace the plunger and tip assembly immediately if any metal is exposed. The exposed metal scrapes the glass of the syringe barrel, producing glass fragments that cut grooves in the PTFE tip. These grooves allow sample to leak past the tip.

Caustic samples or cleaning solutions that seep under the PTFE tip destroy the sharp barb that holds the tip onto the plunger. The tip, so loosened, could slip off during sample aspiration.

Between samples, the syringe should be flushed 5 – 10 times its total capacity to eliminate carryover. Draw and expel the first several flushes of waste to avoid contamination of the sample.

Never store a syringe without cleaning it and wiping dry all external surfaces.



P000284

Recommended Cleaning Procedure:

1. Appropriate solvents are those that dissolve the contaminating substances. Methanol, methylene chloride, acetone and acetonitrile are common. For storage, the final rinsing should be with deionized water followed by acetone.
2. Do not immerse the entire syringe in the solvent; this may damage the adhesives holding parts of the syringe together.
3. To unblock a needle, remove the plunger and fill the barrel with solvent using another syringe. Insert the plunger and push solvent through the needle.
4. Heating will remove semivolatile substances. Remove the plunger before heating. Fixed needle syringes can be heated to 70 °C. Removable needle syringes can be heated to 120 °C. Please refer to the syringe's specific instructions.
5. A needle cleaning kit (Cat. No. 21578) and syringe cleaning solution (Cat. No. 20742) are available from Supelco. The Hamilton syringe cleaner (Cat. No. 20770-U) uses heat and vacuum to clean and restore performance. All of these products are described in the Accessories section of this brochure.

Tips to Assure Accuracy and Precision

Grasp the syringe only by the flange and plunger button. By doing so, variations in liquid measurement due to body heat are avoided.

Pump the plunger with the syringe needle immersed in the fluid to be transferred to expel any trapped air in the needle and syringe.

If the plunger is accidentally removed from the syringe barrel, wipe it carefully with a lint-free tissue. Reinsert the plunger into the barrel and pump deionized water or acetone through the needle and syringe. In the case of plungers with PTFE tips (like Hamilton's Gastight syringes), re-wet the PTFE plunger tip prior to reinserting it into the barrel.

Avoid touching the exposed plunger since any abrasions, scratches, or oil from one's fingers will often interfere with proper plunger operation.

Syringe Lubrication

A clean syringe does not require any lubricating grease. Grease may cause a variety of problems including: sample cross contamination, seizing of the plunger in the barrel or barrel damage.

Minimize the use of a dry syringe.

Ordering Information

Custom Syringes

Because of our long-term relationship with our syringe supplier, we can obtain any of their syringes not listed in this brochure as a custom item. The typical delivery time is two to six weeks, depending on what is ordered. If the custom part number is a stock item for one of the manufacturers (SGE, Hamilton, Valco), expect delivery in only one to two weeks. If you are requesting a custom part number that has a special needle gauge or length, then expect longer delivery time.

Volume Discounts

Supelco offers a large selection of syringes in Multipaks for your convenience and cost-savings. Many are in stock and ready for immediate delivery. The benefits of Multipaks include:

- Economy
- Reduced packaging disposal
- Less lab storage space
- Reduced purchase order placement

Our current syringe MULTIPAK offering is found on page 29.

Calibration Services

Hamilton Company offers a calibration service for their precision and Digital Syringes. With the service, Hamilton provides a Certificate of Calibration with the syringe. The calibration procedure is performed with an unbroken chain of calibrations traceable to N.I.S.T. Calibrated precision syringes are available only at the time of purchase. Supelco can offer this service through Hamilton to our customers. At the time of ordering, specify you want a calibrated syringe, which we will obtain from Hamilton by simply adding the prefix "CAL" to the beginning of Hamilton's part number. Hamilton Digital Syringes are automatically calibrated prior to shipment. A recalibration service is available for the Digital Syringe. Only return the digital unit without the syringe. There is a charge for the calibration plus the cost of a syringe.

If you are interested in a calibrated Hamilton syringe, simply contact our Technical Service Department who will begin the process for you.

The Service You Deserve...from the Company You Trust

Easy Ordering

Supelco offers many ways to easily place your order or inquire about an existing order. You can call, fax, or visit our web site 24 hours a day, 7 days a week.

Please contact us at

USA and Canada:

Phone: 800-247-6628 / 800-325-3010 / 814-359-3441

Fax: 800-325-5052 / 814-359-5459

Web: sigma-aldrich.com/supelco

Europe/International: See back cover for contact details

For more information, visit sigma-aldrich.com

Ready to order products? Searching for Material Safety Data Sheets or other product information? Need a new catalog? Go to sigma-aldrich.com/supelco to search for products, check up-to-the-minute availability, place orders, check order status, or directly trace your order with a tracking number that is hot linked to the carrier's web site. You can check the status and trace an order in two clicks!

On-Time Delivery

Still waiting for syringes that you ordered last week or last month? Not getting responsive customer service? Get the service you deserve today with products that meet your performance demands and are delivered when you need them.

Superior Support

When you want additional information about a product, or help with a problem, our knowledgeable Technical Service chemists and our extensive library of free technical literature are just a telephone call, fax message, or email away. We are always ready to respond to your questions, suggestions, criticisms, and changing needs.

In the USA and Canada, please contact us at the following telephone numbers Monday - Thursday (8AM - 8PM Eastern Time) and Friday (8AM - 6PM Eastern Time).

USA and Canada:

Phone: 800-359-3041 / 814-359-3041

Fax: 800-359-3044 / 814-359-5468

Email: techservice@sial.com

Europe/International: See back cover for contact details

Argentina
SIGMA-ALDRICH DE ARGENTINA, S.A.
Tel: 54 11 4556 1472
Fax: 54 11 4552 1698

Australia
SIGMA-ALDRICH PTY., LIMITED
Free Tel: 1800 800 097
Free Fax: 1800 800 096
Tel: 612 9841 0555
Fax: 612 9841 0500

Austria
SIGMA-ALDRICH HANDELS GmbH
Tel: 43 1 605 81 10
Fax: 43 1 605 81 20

Belgium
SIGMA-ALDRICH NV/SA.
Free Tel: 0800-14747
Free Fax: 0800-14745
Tel: 03 899 13 01
Fax: 03 899 13 11

Brazil
SIGMA-ALDRICH BRASIL LTDA.
Tel: 55 11 3732-3100
Fax: 55 11 3733-5151

Canada
SIGMA-ALDRICH CANADA LTD.
Free Tel: 800-565-1400
Free Fax: 800-265-3858
Tel: 905-829-9500
Fax: 905-829-9292

China
SIGMA-ALDRICH (SHANGHAI)
TRADING CO. LTD.
Tel: +86-21-61415566
Fax: +86-21-61415567

Czech Republic
SIGMA-ALDRICH S.R.O.
Tel: +420 246 003 200
Fax: +420 246 003 291

Denmark
SIGMA-ALDRICH DENMARK A/S
Tel: 43 56 59 10
Fax: 43 56 59 05

Finland
SIGMA-ALDRICH FINLAND OY
Tel: (09) 350 9250
Fax: (09) 350 92555

France
SIGMA-ALDRICH CHIMIE S.à.r.l.
Tel appel gratuit: 0800 211 408
Fax appel gratuit: 0800 031 052

Germany
SIGMA-ALDRICH CHEMIE GmbH
Free Tel: 0800-51 55 000
Free Fax: 0800-649 00 00

Greece
SIGMA-ALDRICH (O.M.) LTD
Tel: 30 210 9948010
Fax: 30 210 9943831

Hungary
SIGMA-ALDRICH Kft
Tel: 06-1-235-9054
Fax: 06-1-269-6470
Ingyenes zöld telefon: 06-80-355-355
Ingyenes zöld fax: 06-80-344-344

India
SIGMA-ALDRICH CHEMICALS
PRIVATE LIMITED
Telephone
Bangalore: 91-80-6621-9600
New Delhi: 91-11-4165-4255
Mumbai: 91-22-2570-2364
Hyderabad: 91-40-6684-5488
Fax
Bangalore: 91-80-6621-9650
New Delhi: 91-11-4165-4266
Mumbai: 91-22-2579-7589
Hyderabad: 91-40-6684-5466

Ireland
SIGMA-ALDRICH IRELAND LTD.
Free Tel: 1800 200 888
Free Fax: 1800 600 222
Tel: 353 1 4041900
Fax: 353 1 4041910

Israel
SIGMA-ALDRICH ISRAEL LTD.
Free Tel: 1-800-70-2222
Tel: 08-948-4100
Fax: 08-948-4200

Italy
SIGMA-ALDRICH S.r.l.
Telefono: 02 33417310
Fax: 02 38010737
Numero Verde: 800-827018

Japan
SIGMA-ALDRICH JAPAN K.K.
Tokyo Tel: 03 5796 7300
Tokyo Fax: 03 5796 7315

Korea
SIGMA-ALDRICH KOREA
Tel: 031-329-9000
Fax: 031-329-9090

Malaysia
SIGMA-ALDRICH (M) SDN. BHD
Tel: 603-56353321
Fax: 603-56354116

Mexico
SIGMA-ALDRICH QUÍMICA, S.A. de C.V.
Free Tel: 01-800-007-5300
Free Fax: 01-800-712-9920

The Netherlands
SIGMA-ALDRICH CHEMIE BV
Tel Gratis: 0800-0229088
Fax Gratis: 0800-0229089
Tel: 078-6205411
Fax: 078-6205421

New Zealand
SIGMA-ALDRICH PTY., LIMITED
Free Tel: 0800 936 666
Free Fax: 0800 937 777
Tel: 61 2 9841 0500
Fax: 61 2 9841 0500

Norway
SIGMA-ALDRICH NORWAY AS
Tel: 23 17 60 60
Fax: 23 17 60 50

Poland
SIGMA-ALDRICH Sp. z o.o.
Tel: 061 829 01 00
Fax: 061 829 01 20

Portugal
SIGMA-ALDRICH QUÍMICA, S.A.
Free Tel: 800 202180
Free Fax: 800 202178
Tel: 21 9242555
Fax: 21 9242610

Russia
SIGMA-ALDRICH RUS, LLC
Tel: +7 (495) 621-5828/5923/6037
Fax: +7 (495) 621-5828/5923/6037

Singapore
SIGMA-ALDRICH PTE. LTD.
Tel: 65-67791200
Fax: 65-67791822

South Africa
SIGMA-ALDRICH
SOUTH AFRICA (PTY) LTD.
Free Tel: 0800 1100 75
Free Fax: 0800 1100 79
Tel: 27 11 979 1188
Fax: 27 11 979 1119

Spain
SIGMA-ALDRICH QUÍMICA, S.A.
Free Tel: 900 101376
Free Fax: 900 102028
Tel: 91 661 99 77
Fax: 91 661 96 42

Sweden
SIGMA-ALDRICH SWEDEN AB
Tel: 020-350510
Fax: 020-352522
Outside Sweden Tel: +46 8 7424200
Outside Sweden Fax: +46 8 7424243

Switzerland
SIGMA-ALDRICH CHEMIE GmbH
Swiss Free Call: 0800 80 00 80
Tel: +41 81 755 2828
Fax: +41 81 755 2815

United Kingdom
SIGMA-ALDRICH COMPANY LTD.
Free Tel: 0800 717181
Free Fax: 0800 378785
Tel: 01747 833000
Fax: 01747 833313
SAFC (UK): 01202 712305

United States
SIGMA-ALDRICH
P.O. Box 14508
St. Louis, Missouri 63178
Toll-Free: (800) 325-3010
Call Collect: (314) 771-5750
Toll-Free Fax: (800) 325-5052
Tel: (314) 771-5765
Fax: (314) 771-5757

Internet
sigma-aldrich.com

World Headquarters

3050 Spruce St., St. Louis, MO 63103
(314) 771-5765
sigma-aldrich.com

Order/Customer Service (800) 325-3010 • Fax (800) 325-5052

Technical Service (800) 325-5832 • sigma-aldrich.com/techservice

Development/Bulk Manufacturing Inquiries SAFC™ (800) 244-1173

The SIGMA-ALDRICH Group



©2007 Sigma-Aldrich Co. All rights reserved.
SIGMA, SAFC, SAFC, SIGMA-ALDRICH, ISOTEC, ALDRICH, FLUKA, and SUPELCO are trademarks belonging to Sigma-Aldrich Co. and its affiliate Sigma-Aldrich Biotechnology, L.P. Riedel-de Haën® trademark under license from Riedel-de Haën GmbH. Sigma brand products are sold through Sigma-Aldrich, Inc. Sigma-Aldrich, Inc. warrants that its products conform to the information contained in this and other Sigma-Aldrich publications. Purchaser must determine the suitability of the product(s) for their particular use. Additional terms and conditions may apply. Please see reverse side of the invoice or packing slip.



Accelerating Customers' Success
through Leadership in Life Science,
High Technology and Service