

Preparative and Purification Liquid Chromatograph

Nexera Prep



Be simple. Be flexible.

The Nexera™ Prep Purification System provides optimal solutions for your laboratory needs.

For Example:

- Easy optimization of preparative parameters and scale up
 - Fractionation simulation for rapid setup of collection logic
 - Column line-up for scale-up from analytical to preparative
- Time- and energy-saving by automation of the purification workflow
 - Collection of target components at high purity by automated desalting
- Expandable to suit the sample/fraction number and volume
 - Choose from a wide range of options for recovery scale and analytical detection
 - Problems are resolved simply, to accommodate a variety of needs.



Streamline and Simplify Establishing the Conditions for Preparative Work — P. 4

Using the Nexera Prep system saves on labor when scaling up from the development of analytical conditions to the conditions for preparative work.

Nexera Prep System



Preparative Work for Target Components at High Purity Levels and High Concentrations — P. 6

The Shimadzu UFPLC, Ultra Fast Preparative and Purification Liquid Chromatograph significantly reduces the cost and labor involved in preparative purification. Additionally, the system not only performs purification of target components, but can also recover impurities with high yield enabling direct impurity analysis.

UFPLC, Ultra Fast Preparative and Purification Liquid Chromatograph System

Preparative Work for Non-UV Absorptive Components — P. 8

With LH-40 and FRC-40 able to perform signal-based logic and collection on up to four signal channels, not having a chromophore is not a limitation. Nexera Prep can use LCMS, RID, and ELSD to detect and/or identify targets for purification.

Nexera Prep LCMS Preparative System



High Separation via Preparative Recycling — P. 10

By repeatedly cycling the sample through the column, the target component can be resolved and recovered from coeluting species or impurities without the need for longer or multiple columns.

Recycling Preparative System



Excellent System Expandability — P. 12

The solvent delivery unit and fraction collector can be selected to suit the recovery volume. Sample introduction and reinjection options cover a wide range of uses. Additionally, the Shim-pack™ Scepter columns feature excellent scalability from analytical to preparative separations with a variety of phases for different applications.



Streamline and Simplify Establishing the Conditions for Preparative Work

Fully Equipped with Functions to Reliably Prepare Target Components

Nexera Prep System

Streamline development of Analysis Conditions and Optimization of Preparative Parameters

In order to separate multiple components, the analysis and fractionation parameters must be optimized, which involves a great deal of work.

Shimadzu provides the Method Scouting system, which investigates conditions at the analytical level. Method Scouting system fully automates method scouting in which combinations of mobile phases and columns are automatically changed, equilibrated, and evaluated, allowing efficient method development.

Further, the preparative system performs automatic simulations using the pre-preparative results, enabling optimization of the fractionation parameters.

This reduces the work involved in investigating conditions, which saves on mobile phase solvent and samples.

Development of Analytical Conditions (Method Scouting System)

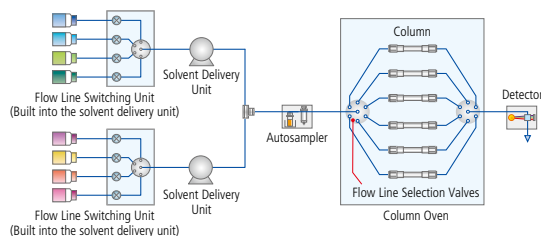

A development is performed to separate the target compounds at the analysis level.

Using the Shimadzu Method Scouting system together with Method Scouting Solution, a special software program, provides a fast and accurate method scouting workflow, which supports heightened efficiency in method development.

Significantly Reduces the Process of Setting Fractionation Parameters

Simple parameter setting by fraction simulator

LabSolutions™ software provides simulation functions that reduce the labor involved in investigating conditions for analytical and preparative work.

With the LabSolutions fractionation simulator (patent pending), specify the peak segment in the chromatogram to fractionate, and the system automatically sets the parameters required for fractionation. This reduces the time spent on setting fractionation conditions to about 1/4 the typical expenditure.

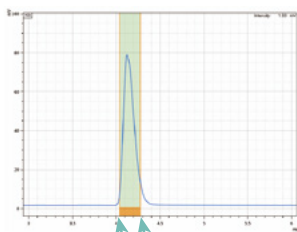

| | |
|-------------------------------------|---------------------|
| <input checked="" type="checkbox"/> | Use |
| Peak Detection Parameter | |
| Slope | |
| <input checked="" type="checkbox"/> | Use Slope |
| Front Slope: | 4321 uV/sec |
| Back Slope: | -1017 uV/sec |
| Level | |
| <input type="checkbox"/> | Use Level |
| Level: | 1000 uV |
| <input checked="" type="checkbox"/> | Slope Disable Level |
| Peak Collection Sensitivity: | 3 |
| Delay Time (Detector Filter): | 1.00 sec |

Noise skipping by new algorithm

When configuring fractionation via automatic peak recognition, noise in the chromatogram is sometimes mistaken for component peaks, resulting in an insufficient number of test tubes for intended collection or improper positioning of collected fractions. With the LabSolutions software Peak Sensitivity Determination function (patent pending), peaks are recognized from the number of data points consecutively exceeding the configured threshold value, to determine whether to fractionate.

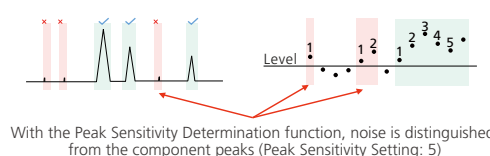
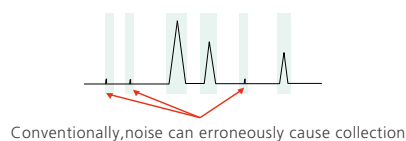

Fraction Purity Checks (LH-40)

A fraction purity check can easily be performed with a single system. Purity checks can be performed without changing the fraction recovery container, so the workload is reduced and throughput is improved.

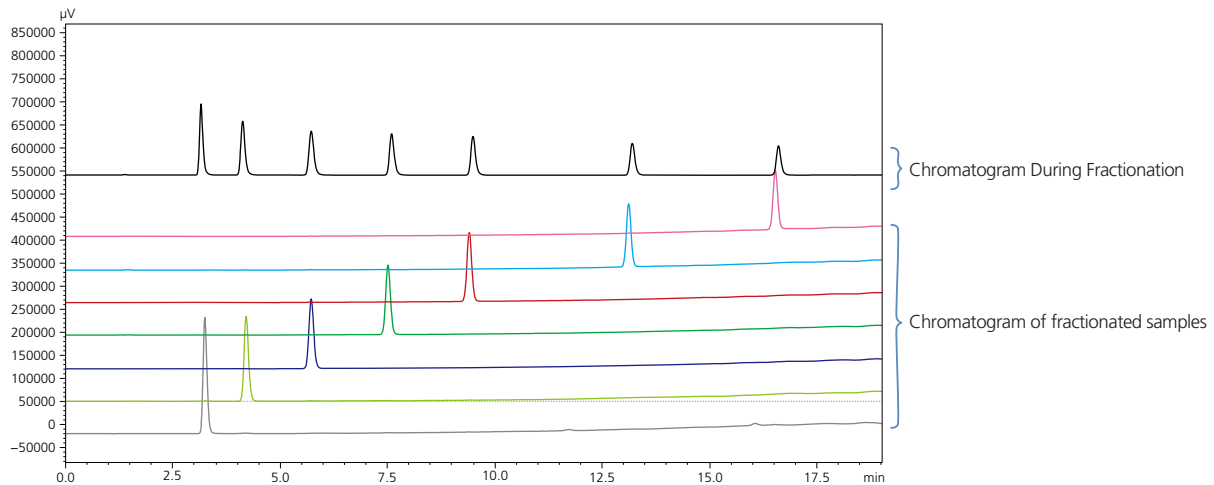

Results of a purity check: the chromatogram during fractionation and the recovered fraction

Note: FRC-40 Analytical kit is required.

Sample Rescue Function Prevents the Loss of Precious Samples (LH-40, FRC-40)

Even if a problem occurs during preparative work, the sample remaining in the system can be recovered. By following the rescue instructions, the precious sample is recovered into the specified container rather than being discarded. Additionally, by using the optional waste collector, samples that cannot be recovered due to fractionation mistakes can be retained.

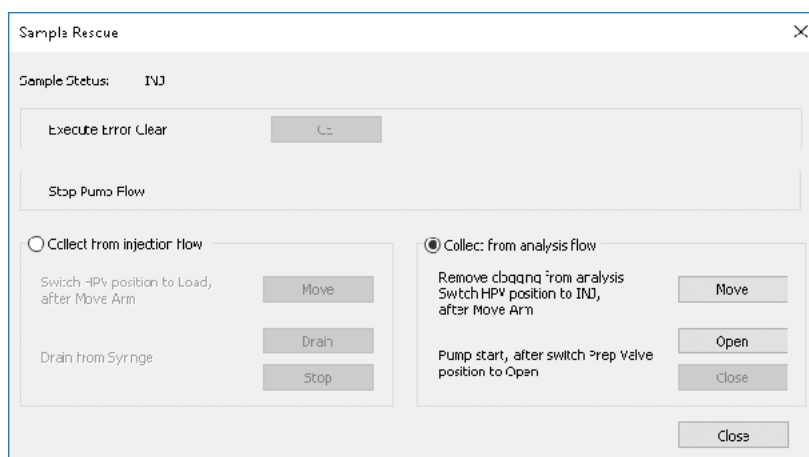

Preparative Work for Target Components at High Purity Levels and High Concentrations

Equipped with Technology for the Trap Enrichment of Target Components UFPLC, Ultra Fast Preparative and Purification Liquid Chromatograph System

Significantly Reduces the Processes Involved from Preparative Work to Purification (Free-basing Treatment) and Powderization

With conventional preparative methods, the fractionated sample contains mobile phase solvent, which leads to unavoidable dilution during fractionation, so the fractionated sample must be enriched and desalted. Such procedures complicate the workflow, and amplify sample loss, labor, and costs.

With the Shimadzu UFPLC, Ultra Fast Preparative and Purification Liquid Chromatograph, all the work from preparation to enrichment, purification, and recovery is performed on-line. This significantly reduces the labor involved in the preparative purification process, and avoids procedural mistakes. Using a proprietary trap enrichment purification technology for the fractionated target components, trace quantities of components contained in mixtures can be recovered at high concentrations and high purity levels. Additionally, since highly volatile organic solvents are used for the recovery of target components, the time needed for evaporation to dryness can be significantly reduced. When recovering ionic target components, counter ions are flushed out by optimization of the solution flowing through, so the target component is recovered as a high purity free base.

With these procedures, and the dedicated Purification Solution™ software, the entire process from the configuration of preparative conditions to the recovery of liquid containing the target compounds can be configured easily from simple and user friendly software.

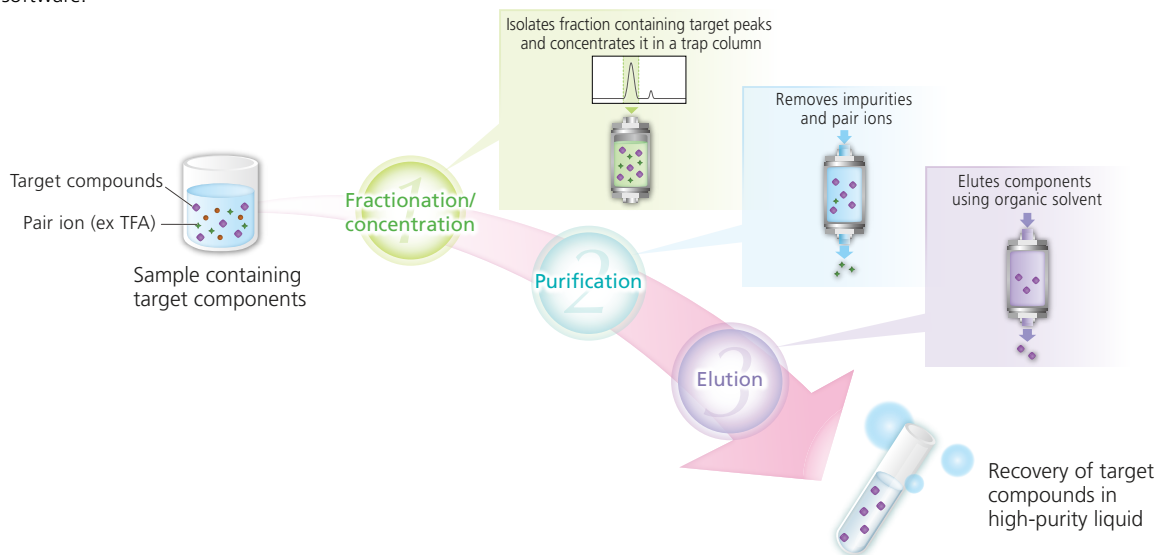

Automation of the Preparative Purification Process

When target compounds are to be powderized, this process can be hindered by a number of factors including the presence of acids, salts, and refractory solvents. With the UFPLC Ultra Fast Preparative and Purification Liquid Chromatograph, these hindrances to powderization can be removed by flushing them out using a trap column, allowing a high purity powder of the target component to easily be obtained by anyone.

Even Trace Components Are Recovered at High Concentrations

Normally, when preparing trace quantity target components, preparative work involves injecting the sample multiple times to obtain sufficient amounts of the target. As a result, the volume of fractionation liquid ultimately obtained increases in proportion to the number of injections, increasing solvent use and dry down time. With the UFPLC Ultra Fast Preparative and Purification Liquid Chromatograph, even with multiple injections, the fraction of the target component is injected into the same trap column for enrichment. The final volume of fractionated liquid from the trap column is minimized, exchanging the weaker loading solvent for a suitable organic solvent. The target component can then be recovered at high purity levels and at high concentrations.

Purification Solution Simplifies Settings Related to Preparative Purification

The special Purification Solution software is equipped with peak tracking functions that enable the target peaks and fractionate and be checked at a glance.

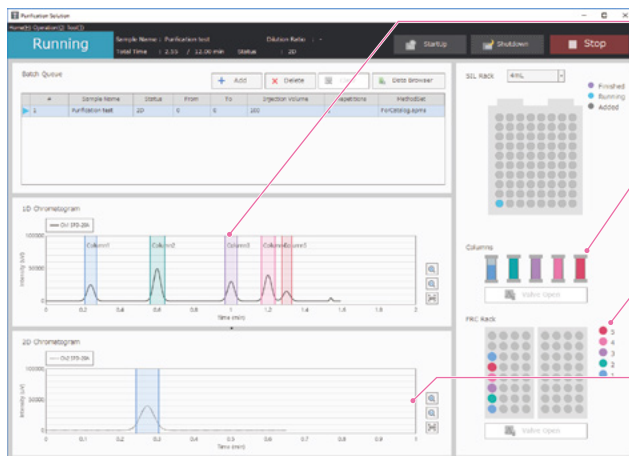

Chromatogram

Individual fraction peaks are color-coded.

Trap Column

Trap columns are displayed with the same color as their corresponding fraction peaks.

Fraction Collector

This displays which vial in the fraction collector was used to collect the eluate recovered from the trap column.

Elution Chromatogram

The chromatogram range is color-coded in accordance with the trap column and fraction collector vial display colors.

Applications

Removal of Salts in the Mobile Phase Solvent

Removal of Ammonium Chloroacetate Salts from Ibuprofen

Ibuprofen, the target component, is cleaned by retention in a trap column. As a result, the ammonium chloroacetate salts contained in the mobile phase solvent were removed. This can prevent the retention of salts contained in the mobile phase solvent during powderization, so that only the target component is recovered.

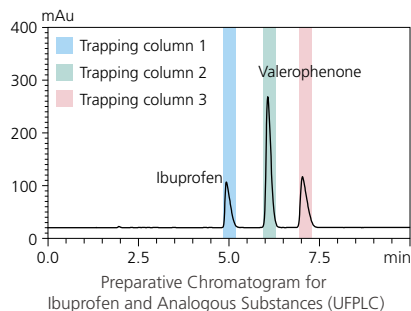

Heightening the Efficiency of Enrichment Purification for Trace Components

High Speed Powderization of Cyclosporine A

The target compound fraction is repeatedly injected into the trap column, enriched by trapping, and eluted by an organic solvent. This enables recovery with a smaller volume of liquid, so subsequent powderization can be performed in a shorter time. In this way, the same volume of powdered sample can be purified in a shorter time versus elution in reverse phase conditions.

Comparison of Preparative LC and UFPLC Fractionation

| Fraction of Cyclopolin A | Fraction vol. (mL) | Fraction conc. (mg/mL) | Drying time* (min) |
|--------------------------|--------------------|------------------------|--------------------|
| Prep LC | 62.5 | 0.04 | 290 |
| UFPLC | 8.10 | 0.29 | 70 |

* Comparison of drying times when a centrifugation enrichment dryer is used

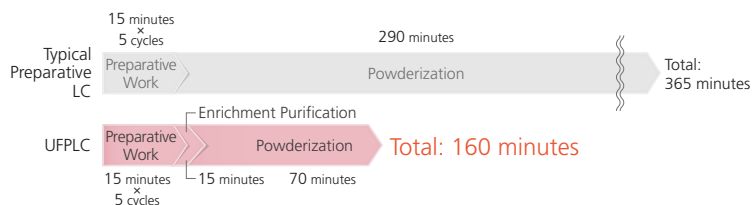

Comparison of Procedural Times for Typical Preparative LC and UFPLC

Preparative Work for Non-UV Absorptive Components

Capable of High Purity Preparation Triggered by up to Four Detector Channel Signals Nexera Prep LCMS Preparative System

Using MS Signal Triggers Enables Recovery with no Target Fraction Omissions

It can be difficult to prepare low UV absorptive components using just a UV signal as the trigger, so there is a risk that the fraction will be missed. By using the MS signal as the trigger, the preparative work can be performed simply, with nothing missed. By specifying the m/z of the target component, fractions can be collected with confidence. The LCMS-2020 mass spectrometer enables high-sensitivity and high-resolution detection for preparative work with no target components omitted.

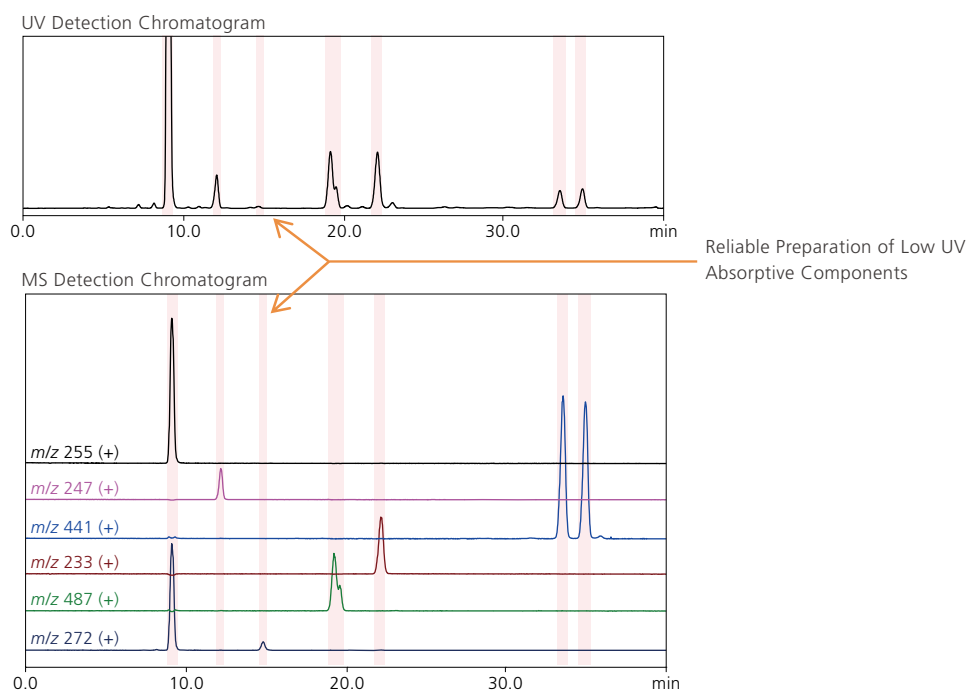

High Purity Recovery of Target Components Using Multiple Signal Triggers

By combining up to four detector signal channels, target components can be recovered at high purity levels.

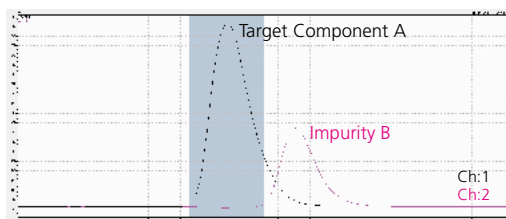

High Purity Recovery of Target Component A
(Using two MS signals as triggers)

The MS signal from the detection of target component A is used as the trigger to start fraction collection. The MS signal from the detection of impurity B, which is eluted in proximity, is used as the trigger to stop fraction. By combining multiple triggers in this way, it is possible to recover only the target component at high purity level. Combining a variety of detector signals as triggers, targets can be recovered at high purity levels, with the confidence that all peaks were detected.



UV-VIS Detector
SPD-40



Refractive Index Detector
RID-20A



Evaporative Light Scattering Detector
ELSD-LT III



Mass Spectrometer
LCMS-2020

Optional Analytical and Preparative Open Solution™ Purification* Software

Efficient System Sharing via Open Access

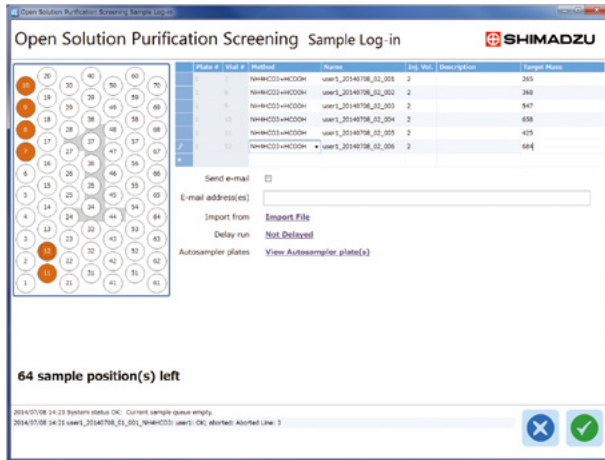

Sample Registration Window

Open Solution Purification simplifies the sharing of preparative systems between several people.

There is a special sample registration window, so preparative work can be performed easily just by having users log in and then specify their method, injection volume and target m/z.

Preparative Operations and Data Analysis can be Performed from a Single Window

With the Open Solution data browser, preparative results can be checked from a single window.

When the test tubes are selected, the peaks are highlighted, and the MS spectrum and UV spectrum for the applicable peak are displayed.

The information for the fractionated compound can be checked easily.

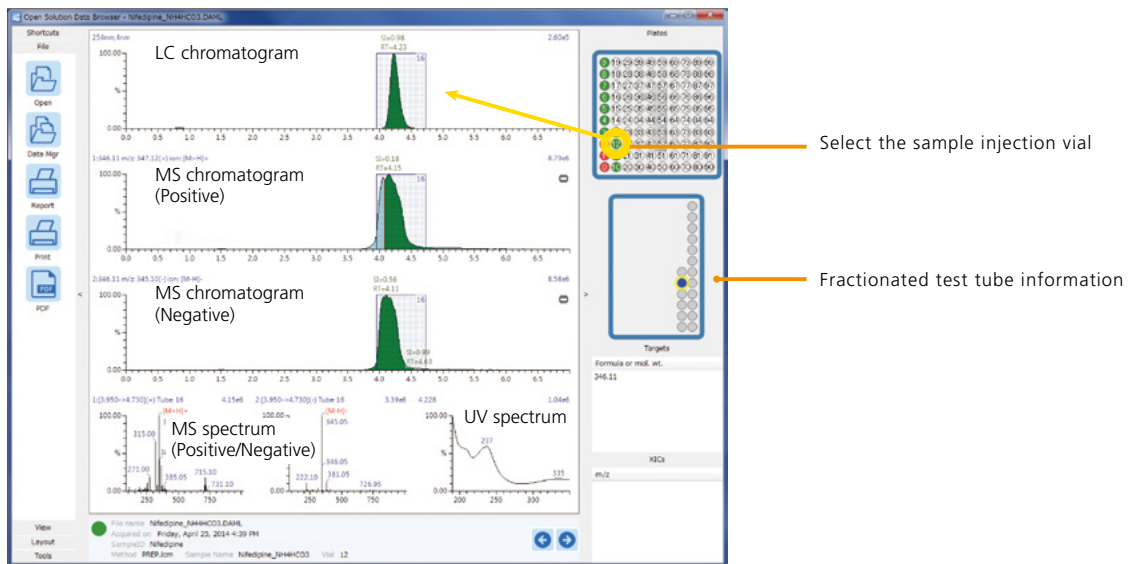

Sample and Fraction Information are aggregated in a Single Window

* This is compatible with the FRC-10A.

High Separation via Preparative Recycling

Components Difficult to Separate can be Recovered at High Purity Levels and at Low Cost Recycling Preparative System

What is the Recycling Separation Method?

Long preparative columns are expensive, as such there is a need to use comparatively lower cost short columns effectively.

In the recycling separation method (closed valve recycling), the eluate liquid containing the target components that has eluted from the separation column is recycled into the column, enabling an equivalent separation capacity to that of a longer column.

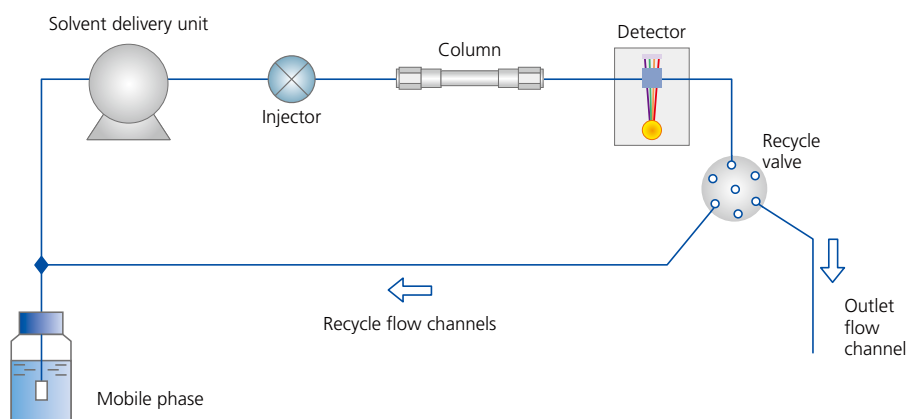

Flow Lines for the Recycling Preparative System

The figure below shows the results of a seven-cycle recycling separation. In the first injection (typical separation), the separation of the two components is insufficient (red area). However, when the column eluate is returned to the column from the detector, it is separated a second time. If this recycling is repeated, the results obtained are equivalent to connecting a number of columns in series corresponding to the number of repetitions. In this example, a 4.0 or better resolution was ultimately obtained with seven recycling separation cycles (blue area).

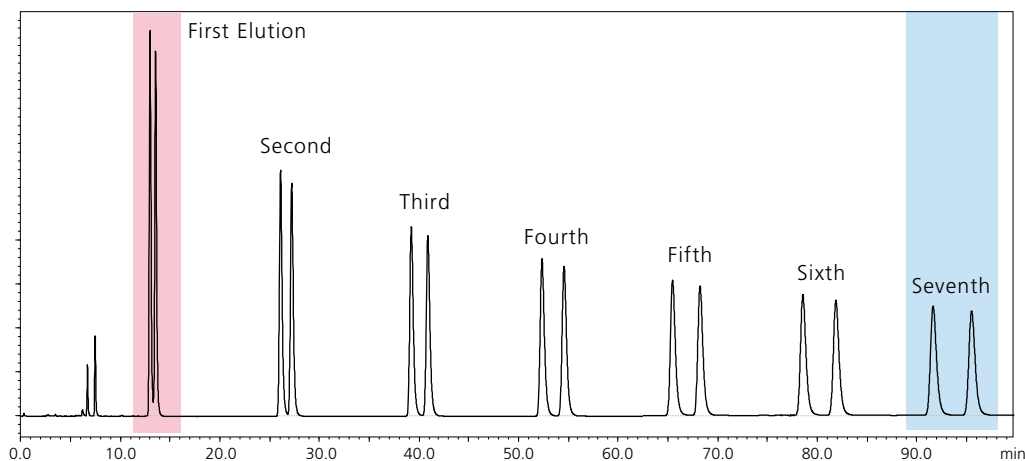

Example of the improvement in separation by recycling: The coeluting peaks (red) are completely separated (blue).

Flowrate : 10 mL/min
Detection wavelength : 254 nm
Column : Shim-pack PREP-ODS(H) 20 mm I.D. × 250 mm L.
Mobile phase : Water/methanol = 1/9 (v/v)
Sample : Mixed 1% n-butylbenzene/iso-butylbenzene solution

Recycle-Assist* — Special Preparative Recycling Software

Perform Automatic Preparative Recycling with a Simple GUI-Based Operating Environment

The graphical user interface (GUI) provides an environment where even novices to preparative recycling can perform operations simply and reliably. A single main window is used for the workflow from recycling to fractionation, thus reducing the risk of wasting precious samples through setting mistakes.

Configure settings for automatic fractionation using the intuitive wizard.

Manually time recycling and fractionation steps while viewing the chromatogram.

Drain (initial state)

Recycling

Fractionation

Visually identify current flow lines.

The chromatogram monitor enables confirmation of the current chromatogram and acquired data.

Recycling Conditions are Completely Set in Three Steps

Just click three points corresponding to the recycling start, recycling stop, and automatic collection start point to complete the settings for the recycling preparation conditions.

Entering complicated numerical parameters is completely unnecessary, so recycling preparative work can start easily.

Development of Recycling Conditions

Click the recycling start point.

Click the recycling end point.

Click the fractionation start point.

The automatic preparative recycling method is created.

* This is compatible with the FRC-10A

Excellent System Expandability

System Configuration Applicable to a Variety of Applications

Solvent Delivery Unit Accommodates a Wide Range of Recovery Volumes

Guidelines for Preparative Scale and Maximum Load

The figure at right shows the guidelines for total component capacity with a 250 mm long column when the target component is highly soluble in the mobile phase, separates from impurities, and ions are suppressed. For isocratic elution, in principle, the total component capacity is proportional to the column volume.

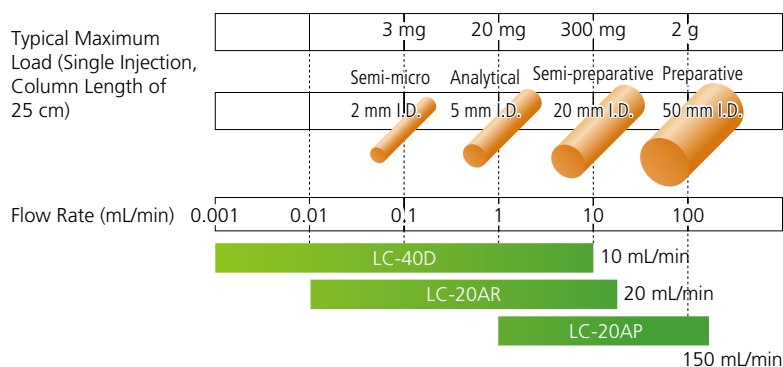

Supports a Range of Applications from High-Precision Analytical to Semi-Preparative

- LC-40D**
- This solvent delivery unit can handle flow rates ranging from those used in analytical scale to those used in semi-preparative (up to 10 mL/min).
 - High-precision analysis is possible even in the semi-micro flow-rate range.



Supports Semi-Preparative and Recycle Preparative

- LC-20AR**
- This solvent delivery unit can handle flow rates used in semi-preparative scale (up to 20 mL/min).
 - Using a recycle kit enables semi-preparative recycling.



Supports Large-Scale Preparative Fractionation

- LC-20AP**
- High flow rates (up to 150 mL/min) enable highly efficient, large-scale preparative fractionation.
 - Large-scale prep solvent delivery fully supports the preparative fractionation workflow including reinjection to assess purity.
 - Combine with an FCV-200AL low-pressure gradient unit to perform gradient analysis using up to four mobile phases.



Specifications

| | LC-40D | LC-20AR | LC-20AP |
|------------------------------------|---|--|--|
| Solvent Delivery Method | | Parallel-type double plunger | |
| Plunger Capacity | 10 µL | 47 µL | 250 µL |
| Maximum Discharge Pressure | 44 MPa | 49 MPa | 42 MPa |
| Flow Rate Setting Range | 0.0001 to 5.0000 mL/min (1.0 to 44 MPa) 5.0001 to 10.0000 mL/min (1.0 to 22 MPa) | 0.01 to 20.00 mL/min | 0.01 to 150.00 mL/min |
| Flow Rate Accuracy | No more than ±1% or ±2 µL/min, whichever is greater (under specified conditions) | No more than ±1% or ±10 µL/min, whichever is greater (0.1 to 5.0 mL/min) | No more than ±1% (1 mL/min, 10 MPa) |
| Flow Rate Precision | No more than 0.06% RSD or 0.02 min SD, whichever is greater | No more than 0.08% RSD or 0.02 min SD, whichever is greater | No more than 0.1% RSD or 0.02 min SD, whichever is greater |
| Constant Pressure Solvent Delivery | | Supported | |
| Plunger Rinsing Mechanism | Optional available | Syringe or rinsing pump (228-39625-41) | Syringe or rinsing pump (228-39625-41) |
| Operating Temperature Range | | 4 to 35°C | |
| Size and Weight | W260 × D500 × H140 mm, 10 kg | W260 × D500 × H140 mm, 16 kg | W260 × D500 × H210 mm, 19 kg |

Shim-pack Scepter Columns

Excellent Stability & Performance using a Wide Range of LC Conditions

Shim-pack Scepter LC columns, which are the next generation organic silica hybrid based columns, are designed for stability and performance in a wide range of mobile phase conditions. With different chemistry characteristics, Shim-pack Scepter columns are effective for method development/scouting under conditions that may compromise traditional silica based columns.

With different particle sizes (1.9 μm , 3 μm , 5 μm) and different column dimensions, Shim-pack Scepter LC columns are fully scalable between UHPLC, HPLC and preparative LC, making method transfer seamless between different laboratory instrumentation.

| | Reversed Phase | | | | |
|------------------------|---|--|------------------|---------------------------|---------------------------------------|
| | C18 | HD-C18 | C8 | Phenyl | PFPP |
| Functional Group | Trifunctional C18 Generic Purpose Type | Trifunctional C18 High Density Type | Trifunctional C8 | Trifunctional Phenylbutyl | Trifunctional Pentafluorophenylpropyl |
| Particle | Organic Silica Hybrid | | | | |
| Particle Size | 1.9 μm , 3 μm , 5 μm | | | | |
| Pore Size | 12 nm | 8 nm | | 12 nm | |
| End Capping | Proprietary | | | | None |
| pH Range | 1 – 12 | | | 1 – 10 | 1 – 8 |
| 100% Aqueous Condition | Yes | No | No | Yes | Yes |
| USP Classification | L1 | L1 | L7 | L11 | L43 |



Example of Scaling Up from Analytical to Semi-Preparative Work

This is an example of scaling up in which seven types of parabens are targeted using a 150 mm long column with a particle size of 5 μm .

The gradient elution conditions investigated at the analytical scale are transitioned to the semi-preparative scale. A comparable chromatogram is obtained at both scales.

Column: Shim-pack Scepter C18-120 (4.6 mm \times 150 mm, 5 μm)
 Column: Shim-pack Scepter C18-120 (20 mm \times 150 mm, 5 μm)

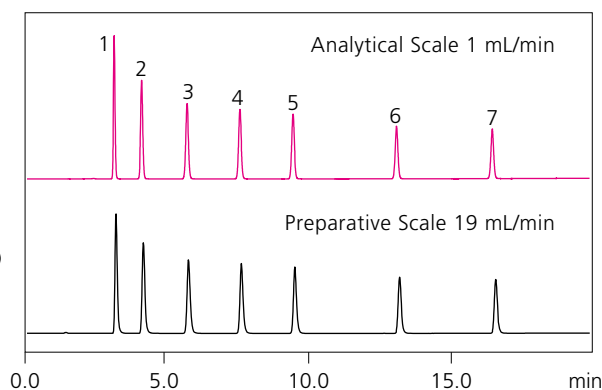

- 1: Methylparabene
- 2: Ethylparabene
- 3: Propylparabene
- 4: Butylparabene
- 5: Pentylparabene
- 6: Heptylparabene
- 7: Nonylparabene

Example of Scaling Up for Parabens

Excellent System Expandability

System Configuration Responds Flexibly to Applications

The LH-40 Liquid Handler, Combination of Autosampler and Fraction Collector

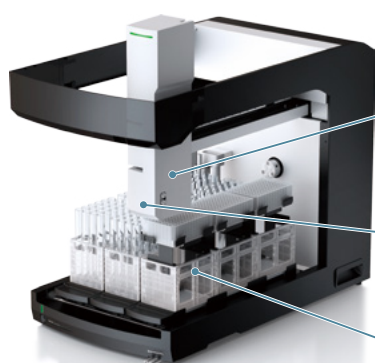

Provides Both a Sample Injection Function and a Fraction Collection Function

A single unit can perform everything from sample injection to fraction recovery.

Suppresses Contamination

A proprietary injection method minimizes carryover, significantly limiting contamination to subsequent samples. (When a 4000 mg/L caffeine sample is injected, the carryover is 0.004 % or less.)

Capable of Injection from a Variety of Containers

With its long needle stroke, the system is compatible with containers of varying depths, including microtiter plates (MTP), vials, test tubes, and sample bottles.

Options

Syringe Kit 20 mL

This kit enables large-capacity injections of 2 mL or more at one time. The maximum injection volume is 20 mL.

Washing Pump

This reduces the washing time for the injection needle, increasing throughput while reducing carryover.

Multi-Liquid Handler Kit*¹

Up to six LH-40 liquid handlers can be connected, making it easy to inject the sample from all LH-40.

*¹ Up to one LH-40 when FRC-40 fraction collectors are connected.

Liquid Surface Detection Needle

This detects the liquid surface level, and automatically determines whether there is any sample present. As a result, only the remaining volume is injected, which prevents the injection of air into columns. Additionally, if no sample is present, the system can proceed to the next sample, reducing needless errors and lost labor.

Analysis Kit

The recovered fraction can be reanalyzed to check the purity.

Autosampler

SIL-10AP

Sample Racks



Manual Injector

Rheodyne® 7725

Optional Sample Loops (Material: SUS)



Sample Coolers

(Block Cooling/Heating: 4 to 70°C)

Specifications

| | LH-40 | | | | SIL-10AP | |
|--------------------------------------|--|---------|---------------------|-----------------------|-----------------------------------|---------|
| Maximum Injection Volume | Up to 2 mL, up to 20 mL (Optional available) | | | | Up to 5 mL | |
| Cooling Function | None | | | | Yes (Optional available) | |
| Compatible Containers and Quantities | 10 mm O.D. test tube | 540 pcs | 1.5 mL vial | 486 pcs* ² | | |
| | 12 mm O.D. test tube | 486 pcs | 4.0 mL vial | 252 pcs | | |
| | 13 mm O.D. test tube | 360 pcs | 13 mL vial | 108 pcs | 1.5 mL vial | 100 pcs |
| | 15 mm O.D. test tube | 252 pcs | 50 mL vial | 54 pcs | 4.0 mL vial | 80 pcs |
| | 17, 18 mm O.D. test tube | 216 pcs | 250 mL bottle | 20 pcs | 13 mL vial | 25 pcs |
| | 25 mm O.D. test tube | 108 pcs | 500, 1000 mL bottle | 12 pcs | | |
| | 30, 35 mm O.D. test tube | 54 pcs | 96 well MTP/DWP | 9 pcs | | |
| Size and Weight | W 390 x H 560 x D 730 mm, 40 kg | | | | W 260 x H 280 x D 320 mm, 18.5 kg | |

*² Available for injection sample container. Not available for fraction container.

FRC-40, Highly Flexible Fraction Collector

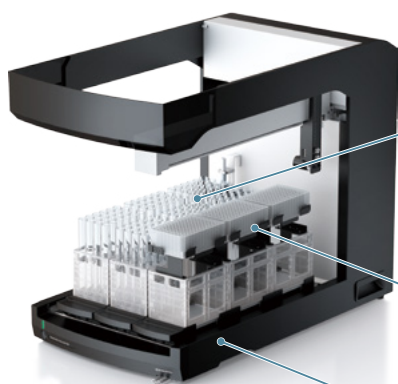

Accommodating Up to 3,240 Test Tubes

Large-scale fractions of the order of one liter can be accommodated, in addition to 96 well MTPs and a variety of test tubes. Up to six units can be connected, allowing users to customize the unit to their capacity needs.

A Variety of Containers Can Be Selected

The system is compatible with various capacity racks to suit the volume needs of almost any workflow, reducing the work involved in switching containers.



Space-Saving Design

With its small installation footprint, up to nine MTP, standard vial racks, or test tube racks can be selected, contributing to the effective use of laboratory space.

Options

Sample Racks

A variety of containers can be placed including MTPs, vials, and various types of test tubes. Six colors are available, so a separate color can be apportioned to each user in order to avoid confusing samples.



Multi Fraction Collector Kit

Up to six FRC-40 fraction collectors can be connected, making it easy to increase the number of fractions.



Compact Design for Small-Volume Samples

FRC-10A

For smaller scale collection, or specialized applications that require enclosure and cooling, the FRC-10A is a compact fraction collector that provides time and signal based triggering. A variety of programmable fractionation functions enable target components to be collected with high purity and high recovery.



Specifications

| | FRC-40 | | FRC-10A | |
|--------------------------------------|---|----------------------------|-----------------------------------|--|
| Maximum Flow Rate | 150 mL/min | | | |
| Fractionation Mode | Configured through a combination of basic mode (initial parameter mode) and time program mode (14 parameters) | | | |
| Cooling Function | None | | Yes (Optional available) | |
| Compatible Containers and Quantities | 10 mm O.D. test tube 540 pcs | 4.0 mL vial 252 pcs | 10 mm O.D. test tube 144 pcs | |
| | 12 mm O.D. test tube 486 pcs | 13 mL vial 108 pcs | 18 mm O.D. test tube 64 pcs | |
| | 13 mm O.D. test tube 360 pcs | 50 mL vial 54 pcs | 35 mm O.D. test tube 16 pcs | |
| | 15 mm O.D. test tube 252 pcs | 250 mL bottle 20 pcs | | |
| | 17, 18 mm O.D. test tube 216 pcs | 500, 1000 mL bottle 12 pcs | | |
| | 25 mm O.D. test tube 108 pcs | 96 well MTP/DWP 9 pcs | | |
| | 30, 35 mm O.D. test tube 54 pcs | | | |
| Size and Weight | W 390 × H 560 × D 730 mm, 40 kg | | W 260 × H 280 × D 320 mm, 18.5 kg | |

Options

Suited to the Target Preparative Method

Column Hub Column Holder Column Holder SLIM

Preparative columns with an I.D. of 20 mm to 50 mm as well as manual switching valves can be attached. The valves can be used for column switching.

Specifications

| | Installable Valves | Installable Columns | Size |
|--------------------|--|--|--------------------------|
| Column Hub | Automatic Switching Valves Up to 4 pcs | Preparative Columns 2 pcs* ³ Analytical Columns 6 pcs* ³ | W 260 × H 560 × D 500 mm |
| Column Holder | Manual Switching Valves Up to 4 pcs | Preparative Columns 2 pcs Analytical Columns 1 pc | W 250 × H 465 × D 400 mm |
| Column Holder SLIM | Manual Switching Valves Up to 5 pcs | Preparative Columns 2 pcs* ⁴ Analytical Columns 1 pc | W 110 × H 625 × D 500 mm |

*³ When attaching three or more analytical columns or two preparative columns to the column hub, the optional "Column Bracket" is needed.

*⁴ If two preparative columns are attached using the Column Holder SLIM, the optional Column Clamp ASSY (P/N: 228-17701-94) is required.



Column Hub



Column Holder



Column Holder SLIM

For Multiple Detection Triggers

A/D Conversion Board Kit

This is required for preparative work using multiple detector triggers. Expand the hardware to suit the number of detection trigger channels required.

Degassing Units

DGU-403 / DGU-405

- A low-capacity degassing unit that uses a special fluoro resin membrane.
DGU-403: 3 flow lines, DGU-405: 5 flow lines
- The maximum operating flow rate per flow line is 10 mL/min.
- Designed for use in analytical and preparative fractionation, this unit is used only when retention time reproducibility needs to be improved during analysis.



DGU-403

Note: When connecting to an LC-20AP, a connection kit must be obtained separately.

Note: LC-20AR connection kit is required when the operating flow rate is more than 10 mL/min.

Helium Degassing Unit

DGU-10B

- Eliminates air bubbles, baseline undulation, drifting, etc. by purging dissolved air from mobile phases.
- The DGU-10B can be used to degas up to four mobile phase solutions with helium gas.
- This unit is switched ON/OFF from the solvent delivery unit or system controller.



DGU-10B

High-Pressure Flow-Line Selection Valves

FCV-20AH₂ / FCV-12AH

- The valve position is controlled by event signal input.
- Valve type: 2-position/6-port rotary valve (recycle valve: 2-position/3-port valve)
- Maximum operating pressure: 34.3 MPa
- Operating pH range: pH 1 to 10
- Operating temperature range: 4 to 35°C
- Storing the FCV-12AH in the Option Box helps reduce the volume of preparative piping, including the recycling flow lines.

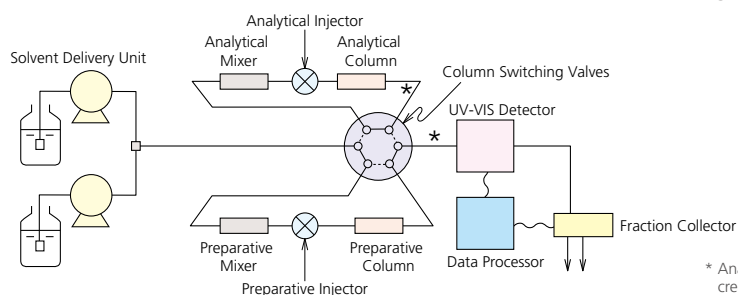

* Analytical samples pass through piping created with 0.3 mm inner diameter tubes.

Low-Pressure Gradient Unit

FCV-200AL

- This low-pressure gradient unit is for the LC-20AP large-volume solvent delivery pump.
- A gradient can be produced with a single pump, enabling gradient preparative work at low cost.
- A single unit is capable of providing up to a four-liquid gradient as well as solvent switching, reducing the work involved in mobile phase investigations during method development.

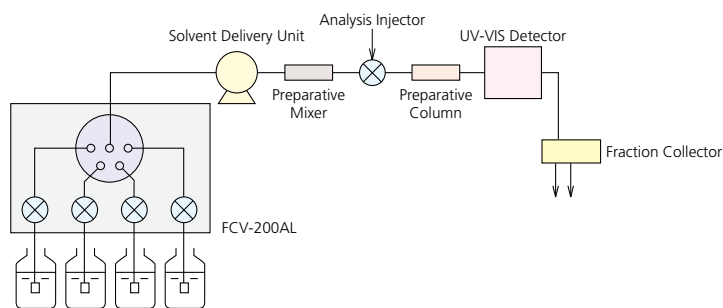

Reservoir Selection Valves

FCV-11AL / FCV-11ALS

FCV-230AL

- Capable of switching solvents using solenoid valves.
- The FCV-11AL/FCV-11ALS provide switching between two solvents. The FCV-11AL can supply up to three solvent delivery units, whereas the FCV-11ALS is used for one unit. It can be controlled from the LC-20AP/20AR front panel directly or through a system controller CBM-20A/20Alite and workstation software.
- The FCV-230AL provides switching between two solvents (optionally four solvents). It can be controlled from the LC-20AP/20AR front panel directly or through a system controller CBM-20A/20Alite and workstation software.



System Selection Guide

What is the total amount of sample load?

How many samples are there?

What are the characteristic of the samples?

Up to 2000 mg

LC-20AP
Shim-pack Scepter (I.D. 20–50 mm)



Up to 300 mg

LC-20AR
Shim-pack Scepter (I.D. 10–20 mm)



Up to 20 mg

LC-40D
Shim-pack Scepter (I.D. up to 4.6 mm)



Up to 252 samples*⁵

LH-40



Up to 80 samples*⁵

SIL-10AP



*⁵ When 4 mL vials are used.

UV Absorptive

SPD-M40 SPD-40/40V



Non-UV Absorptive

LCMS-2020



RID-20A



ELSD-LT III



Are there any other requirements?

Multiple fractions



Multi Fraction Collector System

This is the optimal system when there are many fractions. The number of fraction collectors can be expanded up to six units.

Multi sample capability
Multiple fractions



Multi-Liquid Handler System

This is the optimal system when there are many fractions. LH-40 is connected up to six units. It makes it easy to inject the sample from all LH-40.

What is the number of fractions?

Up to 540 samples*⁶

LH-40



FRC-40



Up to 144 samples*⁶

FRC-10A



*⁶ When test tubes with an O.D. of 10 mm are used

— Sample System Configuration —

Preparative LC System



This system supports a wide range of loads, injection volumes, and number of fractions.

It can be used as an all-purpose system to support a diverse range of samples.

Preparative LCMS System



Target components can be selectively prepared with no omissions using LCMS.

High separation at low cost



Recycling Preparative System

This is the optimal system for obtaining high separation at low cost.

Purity checks



Everything up to fraction purity checks after preparation can be performed with a single system.

Nexera, Shim-pack, LabSolutions, Purification Solution and Open Solution are trademarks of Shimadzu Corporation or its affiliated companies in Japan and/or other countries.
Rheodyne is a registered trademark of IDX Health & Science, LLC.



Shimadzu Corporation

www.shimadzu.com/an/

For Research Use Only. Not for use in diagnostic procedures.

This publication may contain references to products that are not available in your country. Please contact us to check the availability of these products in your country.

Company names, products/service names and logos used in this publication are trademarks and trade names of Shimadzu Corporation, its subsidiaries or its affiliates, whether or not they are used with trademark symbol "TM" or "®".

Third-party trademarks and trade names may be used in this publication to refer to either the entities or their products/services, whether or not they are used with trademark symbol "TM" or "®".

Shimadzu disclaims any proprietary interest in trademarks and trade names other than its own.

The contents of this publication are provided to you "as is" without warranty of any kind, and are subject to change without notice. Shimadzu does not assume any responsibility or liability for any damage, whether direct or indirect, relating to the use of this publication.