

Multi-Channel X-ray Fluorescence Spectrometer

MXF-2400



Simultaneous determination of up to 36 major and impurity elements in nondestructive analysis.
(Analysis range: ${}^4\text{Be}$, ${}^5\text{B}$, ${}^6\text{C}$ to ${}_{92}\text{U}$)

An X-ray tube that supports the use of a 4 kW (Thin Window) has been installed to further enhance performance.



FACTORY LAB

MXF-2400

The Shimadzu MXF-2400 is an improved version of the Shimadzu Multi-Channel X-ray fluorescence spectrometer, which has been rated highly in the overseas market as well as in the domestic market.

The latest hardware designed to fully utilize the principle of X-ray fluorescence spectrometry and the data processing unit that uses various software programs to permit automatic management of analysis data combine to provide high analytical productivity both in R&D and production control. Up to 36 elements can be simultaneously determined by the fixed monochromator and up to 48 elements can be determined sequentially by the optional scanning monochromator. High analytical precision is provided even in high sensitivity analysis of a few ppm quantity level.

High level of automation and labor saving

Impurity elements as well as major elements in various types of samples can be readily determined, for the purpose of quality control and R&D. About 36 elements in a sample can be determined in a minute. The operation is stable enough to permit unattended operation to save labor and running cost.

The optional scanning monochromator is convenient for automated qualitative analyses in R&D.

Quality control

The MXF-2400 presents analytical results in a short time with excellent stability in quality control. This minimizes the number of off-grade products.

Production control

Samples may be taken from the production line and analyzed without delay. The data are fed back to control the material mixing properly.

The result is stable and high quality.

Applications

■ Iron and steel industry

Pig iron, stainless steels, low-alloy steels, slag, sintered ores, ferroalloys, special steels, surface-treated steel plates, plating solutions.

■ Nonferrous metal industry

Copper alloys, aluminum alloys, aluminum ingot, lead, zinc, magnesium alloys.

■ Ceramic industry

Cement raw mix, clinker, limestone, clays, glasses, bricks.

■ Electric and electronic materials

Semiconductors, ceramics, magnetic disks, magnets batteries, PCBs.

■ Chemical industry

Synthetic fibers, catalyzers, paints, dyes, pharmaceuticals, cosmetics, cleanser, other organic and inorganic products.

■ Petroleum and coal industry

Heavy oils, lubrication oils, polymers, coals, cokes.

■ Agriculture and food industry

Soils, fertilizers, pasture, leaves, plants.

■ Pollutants

Factory waste water, sea water, river water, airborne dust, industrial wastes.

■ Papers and pulps

Contents

P. 04 Principle

P. 12 Component Concentration Range Examples for Representative Samples in Some Typical Fields

P. 19 Optional Accessories for Sample Preparation

P. 05 Construction

P. 14 High Level Data Processing

P. 23 Installation Requirements

P. 06 Features

P. 18 Specifications

Principle

When X-rays hit a sample, atoms in the sample are excited and release the secondary X-rays, which are also called fluorescent X-rays. Since the wavelength of secondary X-rays is peculiar to the element concerned, the sample can be qualitatively determined by measuring that wavelength. Also, since the fluorescent X-ray intensity is proportional to the concentration of the element, quantitative determination is made by measuring the fluorescent X-ray intensity of the wavelength peculiar to each element.

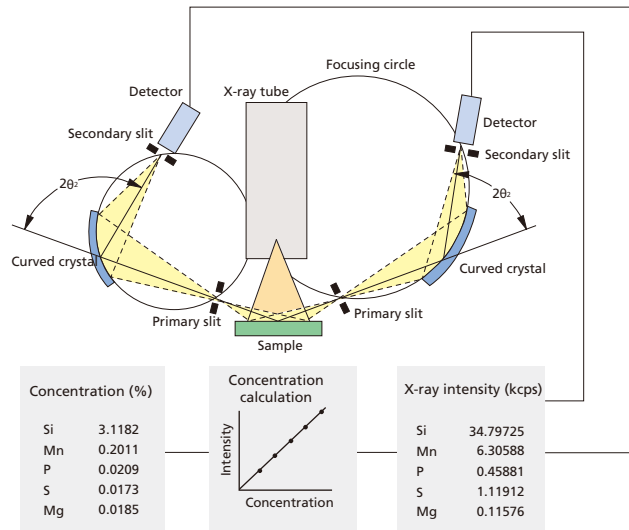

Spectrometer Unit

This unit disperses the fluorescent X-rays generated from the sample, measures the intensity of the X-rays of the particular wavelength, and converts that intensity into electric signals. High quality curved crystals are used for dispersion. The MXF-2400 uses one monochromator for one element, and up to 36 monochromators can be installed together to permit simultaneous determination of up to 36 elements. Use of the optional scanning monochromator provides automatic qualitative analysis and allows up to 30 elements to be preset for quantitative analysis.

Measuring Electronics

The electric pulses corresponding to the number of X-ray photons are counted and recorded. — The output pulse signal of the detector is amplified and its interfering spectrum signals are removed by the pulse height analyzer. Then the signal is measured by the scaler, processed by the microprocessor, and then transmitted to the data processing unit.

X-ray Power Source

This unit supplies power to the X-ray tube which emits the excitation X-rays (primary X-rays). It consists of a high-voltage transformer and an X-ray power controller.

Data Processing Unit

X-ray intensities are converted into concentration values of the elements concerned through the use of the conversion equations (calibration curves) predetermined using standard samples. The results are presented on the display or the printer.

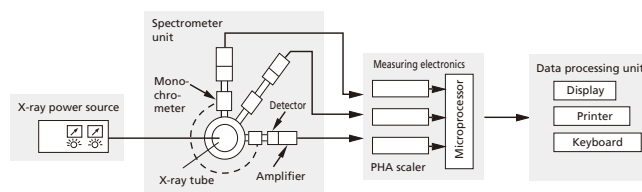

Construction



1 X-ray Spectrometer (Installed in the case)

Up to 36 monochromators are radially arranged around the X-ray tube. The case of the X-ray spectrometer is temperature-controlled.

2 Sample Turntable (with dust-proof cover)

Up to eight samples may be loaded together for automated successive analysis. An external automatic sample feeder and/or automatic sample pretreatment unit may be connected to this turntable.

3 Sample Feeding Unit (Installed behind the panel)

The swing arm system accurately positions the sample.

4 Maintenance Panel

This unit displays the status of each part and has manual switches for checking.

5 X-ray Tube Cooling Unit

This unit circulates cool, distilled water to the X-ray tube. The distilled water is cooled externally.

6 Data Processing Unit

The operation of the MXF-2400 is made via the keyboard of this unit. This unit has various high-level data handling functions, which provides advanced analysis by easy operation.

7 X-ray Power Control Unit and Processor Unit

The X-ray power control unit controls the output power of the X-ray tube with such a high stability that it is not necessary to use a motor generator in most cases. The processor unit incorporates the X-ray intensity measuring circuit and the microprocessor, which counts X-ray pulses and controls all the other units.

8 DC Power Source Unit

This unit supplies DC power to the control units.

9 Switchboard

The necessary power source is one three phase 200 VAC or 220 VAC line.

Features

1 The World's First Multi-Channel Fluorescent X-ray Spectrometer to be Installed with a 4 kW (Thin Window) X-ray Tube

Sensitivity has been enhanced to approximately 1.3 times for heavy elements and 1.7 times or more for light elements (elements lighter than Cl).

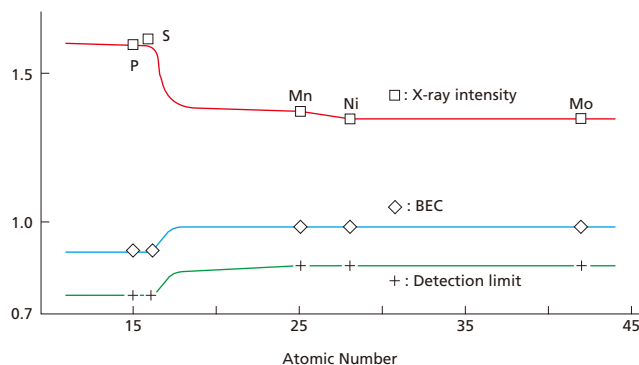

2 Excellent Analytical Accuracy from Minute Regional Areas to Whole Areas

The converging spectrometer system is one of Shimadzu's original designs. The fluorescent X-ray focus doesn't diverge, and becomes extremely small at the secondary slit so that reflected X-ray intensity is extremely high, and resolution is good in comparison with other systems.

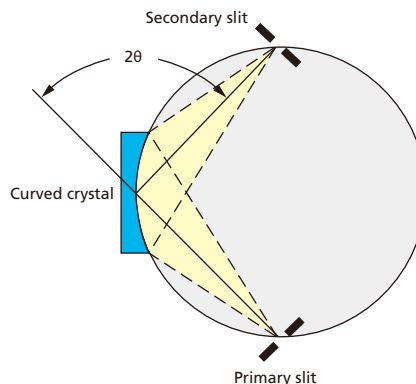

3 Excellent Long-term Stability and Maintenance-free Characteristics

Through the development of original technology by Shimadzu an excellent gas sealed detector (SPC) is used to obtain long-term stability and maintenance-free characteristics over a wide range (^{11}Na to ^{92}U) of light elements including Na which normally only could be analyzed using a gas flow detector (FPC).

Shimadzu's own original gas sealed detector has the following features.

- 1) Starting up X-ray signals is fast, and a large number of X-ray signals can be counted at a high speed.
- 2) CO_2 is mixed in with the inert gases (Ne, Ar, Kr) to give good gas stability, and the core wire does not become contaminated as there is no resolution deterioration due to ionization.
- 3) As there is no gas piping, consideration of the surroundings is not required, and excellent long-term stability is assured. (The device is ideal for process control and automatic analysis as the number of calibration curve adjustments and α/β correction can be minimized.)
- 4) As the gas is sealed in the device, there is no maintenance, which makes the product extremely permanent. Moreover, the whole spectrometer unit is kept stable as a thermostat in the device continually maintains the temperature to within $\pm 0.2^\circ\text{C}$ of the set temperature.

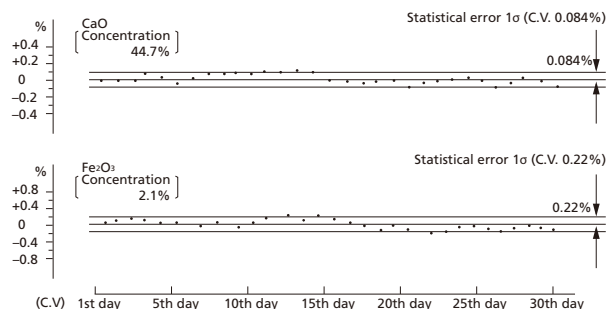

4 The Effect of Nearby or Interfering Elements can be Reduced

A detector suitable for each element can be selected from between the gas sealed detector sealed with gas appropriate for elements such as Ne, Ar and Kr (selection can be made over a broad range from 11Na to 92U), the scintillation detector, and the gas flow detector. The effect of nearby or interfering elements can be minimized as the optimum detector can be selected to provide excellent detection efficiency and good resolution for each element.

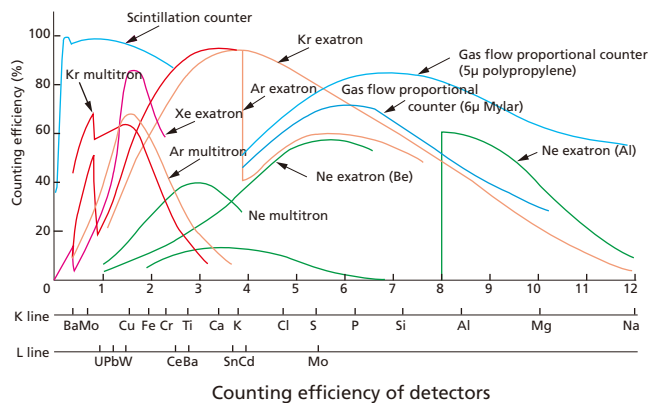

5 Excellent Measuring Reproducibility for Light Elements

Using Shimadzu's original vacuum stabilizer (patented), a constant vacuum can be maintained during measuring. And as the change in X-ray intensity due to the change in the degree of vacuum (change due to air absorption) can be suppressed, excellent measuring reproducibility can be achieved for light elements (such as Al and Si) and superlight elements (such as Be, B and C).

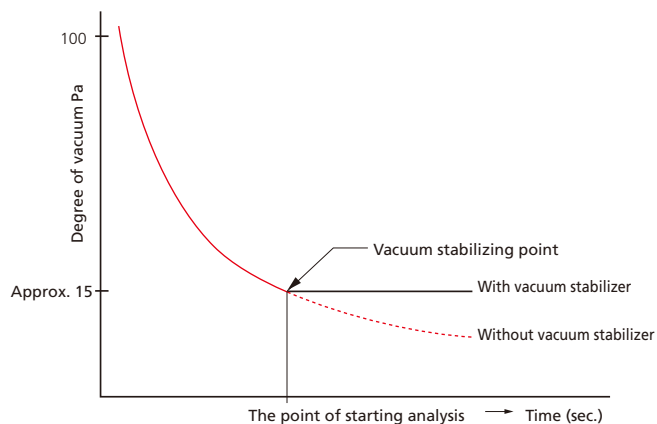

6 Excellent Long-term Stability for Superlight Elements (Be, B, C, N, O, F)

The gas flow detector (FPC) has excellent long-term stability as pulse height distribution is stabilized through the use of an automatic core wire winding system (Shimadzu patent) and a gas density stabilizer with CPU control system.

The automatic core wire winding system is different to the previous core wire cleaning system and manual core wire winding system in that core wire winding is continuously automatic (5 mm per day) so that the core wire does not become contaminated, analysis can be conducted always with a new core wire, and maintenance is not needed.

Furthermore, the PR gas flow and density necessary for the gas flow detector achieves stability in the gas density stabilizer with CPU control system.

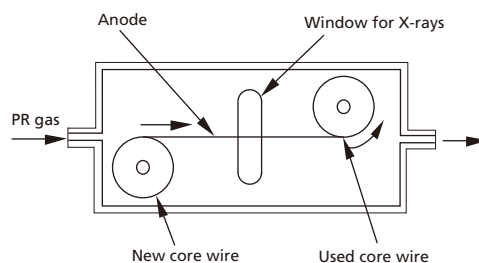
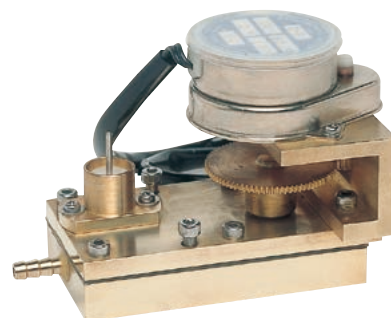

7 Enhanced Sensitivity for Superlight Elements

The layered structure analyzer (LSA), which uses curved crystals for convergence, provides almost ten times higher sensitivity for X-rays than conventional detectors.

Unlike the conventional dispersing crystals, the LSA has synthetic multilayer structures.

The spacer is made of the material and has the thickness that gives the best lattice constant to sense X-ray intensities at the highest sensitivity for such elements as Be, B, C, N, O, F, Na, and Mg.

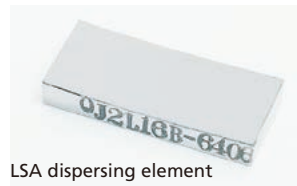

LSA dispersing element



Monochromator for LSA

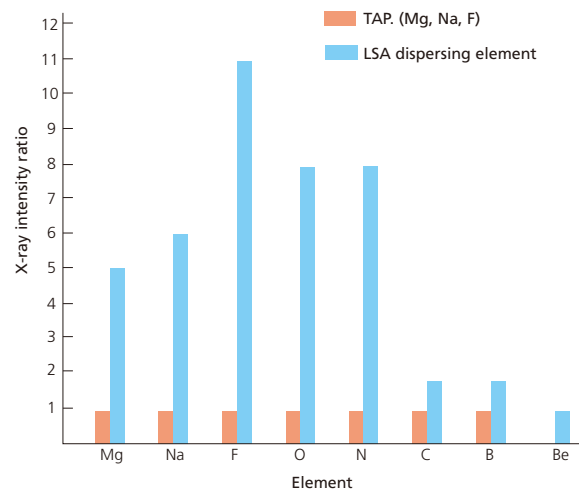

X-ray Intensity Comparison between LSA Dispersing Element and TAP Crystal Total Reflection

8 Wide Dynamic Range

The Shimadzu's original pulse counting circuit and the counting error correcting circuit combine to provide a wide dynamic range: one calibration curve can cover the concentration range more than 3,000,000 cps, from 0% to 100%. High accuracy is ensured even in high concentration region where the X-ray intensity is very high.

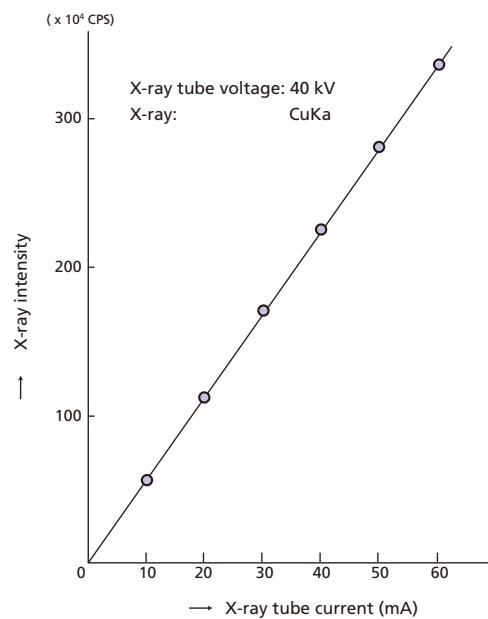

Linear Calibration Curve more than 3,000,000 cps

9 Analytical Information can be set for Each Individual Sample Form and Each Individual Element

Analytical conditions such as optimal X-ray output and PHA (pulse height analyzer) range can be freely set for each individual sample form and element. Also, an automatic sensitivity correction function (counting loss correction) can be used.

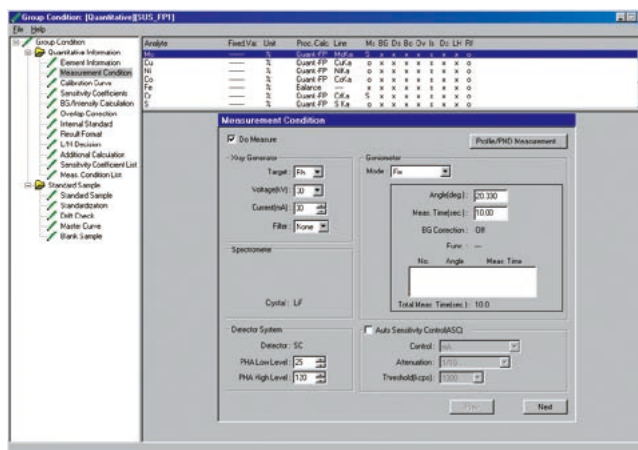
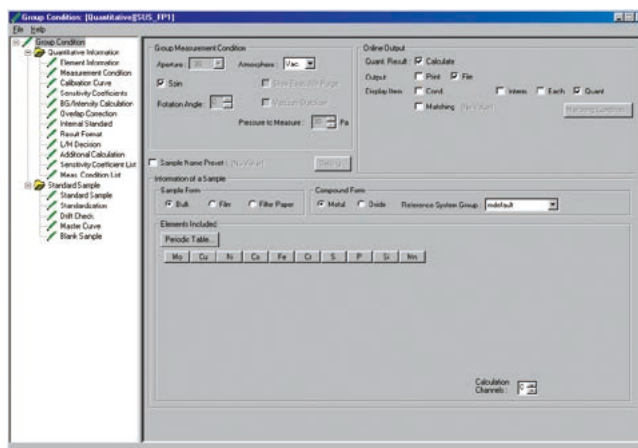

10 Simultaneous Determination of up to 36 Major and Impurity Elements

The 36 fixed monochromators detect impurity elements as well as major elements with high reliability. The detection limit is a few ppm concentration level.

The scanning monochromator permits automatic qualitative determination and may also be used for quantitative determination.

There is a strong demand for the method to analyze not only major elements but also impurity elements, in order to enhance the quality of the final products. The technique of X-ray fluorescence spectrometry has detection limits of a few ppm concentration level and is applicable to various types of samples.



11 Automatic Startup and Stop (Standby) of Device is Possible

The X-ray unit can be automatically started up by registering the device startup date and time in advance.

Automatic stop (standby) can be set in the same way.

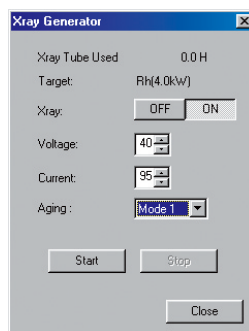

12 Good Operability from Eight Sample Turrets with Dust-proof Cover

Standard samples and control samples can be safely set on the turrets for long periods as the device comes with a dust proof cover.



Typical Detection Limits and Repeatability

13 High Sensitivity and High Precision

The adoption of the new X-ray tube of the end-window type and the short distance between the X-ray output port of the X-ray tube and the sample provides high intensity of the fluorescent X-rays; this enhances the sensitivity for trace elements and improves the detection limits.

The use of curved crystals and curved dispersion elements enhances the resolution, while the adoption of a gas sealed proportional counter, an automatic core wire winding type detector, temperature control unit for the spectrometer, and the high-performance counting circuit provides high precision.

The degree of vacuum is controlled and stabilized by the CPU, which also enhances the stability of light-element analysis.

Low-alloy steel Integration time: 40 sec.

	Si	Mn	P	S	Ni	Cr	Cu	Mo
Detection limit	0.0013	0.0006	0.00045	0.0004	0.0008	0.0002	0.0006	0.00045
Repeatability								
Concentration	0.223	0.66	0.015	0.017	1.99	0.69	0.042	0.19
Standard deviation	0.0011	0.0008	0.0002	0.00022	0.0016	0.0007	0.0003	0.00025
Coefficient of variation	0.5	0.13	1.3	1.3	0.08	0.1	0.7	0.13

Cast iron Integration time: 40 sec.

	C	Si	Mn	P	S	Mg
Concentration	3.57	1.7	0.503	0.047	0.042	0.041
Standard deviation	0.017	0.0017	0.0004	0.00025	0.0002	0.0008
Coefficient of variation	0.49	0.1	0.08	0.55	0.47	2

Copper alloy Integration time: 40 sec.

	Cu	Zn	Mn	Si	Al	Sn	Pb	Fe
Concentration	57.0	38.0	0.26	0.014	0.06	0.17	0.011	0.019
Standard deviation	0.01	0.01	0.00035	0.00068	0.00042	0.0007	0.00033	0.00027
Coefficient of variation	0.018	0.026	0.13	4.8	0.7	0.4	3	1.4

Ceramic cement Integration time: 40 sec.

	SiO ₂	Al ₂ O ₃	Fe ₂ O ₃	CaO	MgO	SO ₃	Na ₂ O	K ₂ O
Concentration	14.0	3.0	2.0	43.0	0.8	2.0	1.0	0.4
Standard deviation	0.0063	0.0024	0.0008	0.006	0.004	0.0014	0.006	0.0005
Coefficient of variation	0.045	0.08	0.04	0.014	0.5	0.07	0.6	0.13

14 Rapid and Precise Sample Setting

The swing arm system sets a sample precisely within 5 seconds, in a single motion. This simple design minimizes down time and ensures stable performance even in high-duty operation.

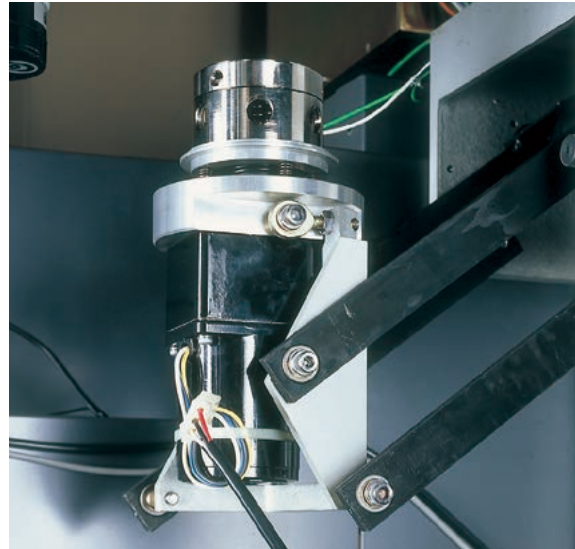
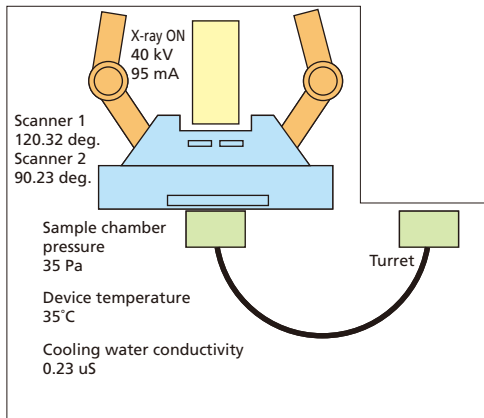

15 Automatic Qualitative Determination

The scanning monochromator permits automatic qualitative analysis.

The 2θ-PHA linkage system (detector high voltage linkage system) excludes the influence of higher-order lines to provide easy-to-read profiles.

In qualitative analysis, 8 samples may be continuously analyzed, and then the peaks are identified and the results are displayed and printed out.

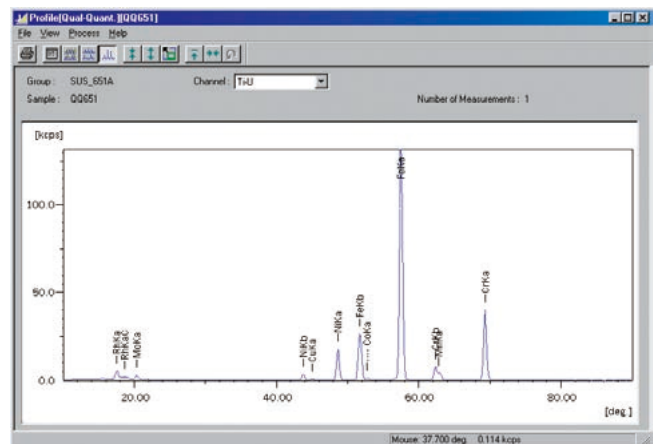

Component Concentration Range Examples for Representative Samples in Some Typical Fields

Use them for reference for your plan.

1 Iron and Steel

Cast iron, pig iron, stainless steel, low-alloy steel, converter slag, blast furnace slag, iron ore, sinter ore, various ferroalloys

Iron and steel, general (%)

Sample Element	Steel	Iron ore	Sintered ore	Blast furnace slag	Converter slag
Si	0.01 to 2.5	0.5 to 20.0	3.0 to 8.0	20.0 to 40.0	10.0 to 30.0
Mn	0.01 to 2.5	0.01 to 1.5	0.01 to 0.5	0.5 to 5.0	0.5 to 5.0
P	0.005 to 0.05	0.005 to 0.3	0.01 to 0.3		0.5 to 5.0
S	0.003 to 0.05	0.005 to 0.5	0.005 to 0.5	0.5 to 1.5	0.05 to 0.2
Fe		30.0 to 70.0	50.0 to 65.0	0.1 to 2.0	1.0 to 30.0
Ni	1.0 to 15.0	0.001 to 0.1			
Cr	0.5 to 25.0	0.001 to 0.1			0.05 to 10.0
Mo	0.01 to 3.0				
As	0.005 to 0.1	0.005 to 0.1			
F				5.0 to 10.0	
Al	0.01 to 0.1	0.1 to 5.0	0.1 to 3.0	10.0 to 15.0	0.5 to 5.0
Mg		0.01 to 2.0	0.01 to 0.2	1.0 to 7.0	0.5 to 5.0
Ca	0.005 to 0.1	0.01 to 2.0	5.0 to 10.0	35.0 to 50.0	40.0 to 70.0
V	0.001 to 0.5	0.001 to 0.1			
Cu	0.01 to 0.5	0.005 to 0.1	0.01 to 0.1		
Pb		0.005 to 0.1	0.005 to 0.5		
Ti	0.001 to 0.5	0.01 to 0.5	0.01 to 0.5	1.0 to 5.0	1.0 to 5.0
Co	0.1 to 0.5	10.0 to 20.0			
Zn		0.005 to 0.1	0.005 to 0.1		0.01 to 1.0
Sn	0.005 to 0.1	0.005 to 0.1			

Ferroalloy related (%)

Sample Element	Ferronickel	Nickel matte	Ore	Slag	Firing ore
Ni	15 to 31	17 to 75	1 to 13	0.01 to 0.40	1 to 5
Co	0.1 to 1.0	0.1 to 1.0	0.02 to 0.15		
Cr	0.01 to 2.5		0.5 to 4.0		
Si	0.01 to 7		10 to 25		
P	0.001 to 0.05				
S	0.001 to 0.30	10 to 30			
Cu	0.01 to 0.10	0.5 to 4.0			
Fe		0.1 to 3.0	7 to 17	2 to 8	10 to 30
Mg			10 to 20	18 to 24	
Ca				0.1 to 5.0	

Stainless steel related (%)

Sample Element	stainless steel	Stainless steel slag
Mg		8 to 23
Al	0.01 to 2	0.1 to 15
Si	0.1 to 1	17 to 40
P	0.005 to 0.1	0.04 to 2
S	0.005 to 0.1	0.01 to 1
Ca		2 to 63
Ti	0.01 to 1	0.01 to 0.1
V	0.005 to 0.2	
Cr	5 to 40	0.1 to 45
Mn	0.1 to 2.5	0.1 to 10
Fe	10 to 100	0.1 to 20
Co	0.01 to 1	
Ni	0.1 to 20	0.1 to 10
Cu	0.05 to 0.5	
Mo	0.005 to 5	
Sn	0.005 to 0.1	
Nb	0.01 to 2	

Steel and cast iron (%)

Sample Element	Low-alloy steel	High-alloy steel	Cast iron
C	0.02 to 2	0.02 to 2	2 to 3.7
Si	0.05 to 1.00	0.05 to 1.00	0.5 to 5.0
Mn	0.05 to 2.00	0.05 to 2.00	0.05 to 2.0
P	0.005 to 0.05	0.005 to 0.05	0.005 to 0.6
S	0.005 to 0.05	0.005 to 0.05	0.005 to 0.3
Ni	0.01 to 5	0.05 to 15.0	0.01 to 5.0
Cr	0.01 to 5	5 to 25.0	0.05 to 3.0
Mo	0.01 to 2	0.01 to 2	0.01 to 1.0
V	0.01 to 0.5	0.01 to 0.5	
W	0.01 to 1.0	0.01 to 5.0	
Co		0.01 to 2.0	
Cu	0.01 to 0.5	0.01 to 1.5	0.01 to 2.0
Ti	0.001 to 0.2	0.001 to 0.2	0.001 to 0.3
Al	0.01 to 0.5	0.01 to 0.5	0.01 to 0.5

Surface treatment coatings, plating related

Sample Element	Chromate conversion coating	Nickel/zinc plating	Tin plating	Brass-plated copper wire
Cr	1 to 20mg/m ²			
P		0.1 to 5g/m ²		
Zn		0.001 to 200g/m ²		
Ni		0.001 to 200g/m ²		
Sn			0.001 to 30g/m ²	
Brass				1 to 10g/kg

2 Non-Ferrous Metals

Copper alloy, aluminum alloy, nickel alloy, magnesium alloy, precious metals

Copper alloy (%)

Sample Element	Brass	Nickel brass
Cu	55 to 90	35 to 60
Sn	0.01 to 15	0.01 to 5
Pb	0.005 to 15	0.01 to 5
Fe	0.005 to 6	
Ni	0.005 to 1	7 to 20
Mn	0.005 to 5	0.01 to 0.5
Al	0.03 to 15	
Si	0.01 to 6	
P	0.002 to 1	
S	0.001 to 0.5	
Cr	0.005 to 1	
Zn	0.01 to 45	10 to 30
As	0.005 to 0.5	
Sb	0.001 to 1	
Cd	0.005 to 0.5	
Te	0.005 to 1	
Zr	0.005 to 1	
Bi	0.005 to 0.1	

Aluminum related

(%)

Sample Element	Aluminum alloy	High-purity aluminum
Cu	0.005 to 10	0.001 to 0.05
Fe	0.01 to 2	0.001 to 0.05
Si	0.01 to 20	0.001 to 0.05
Mn	0.01 to 1	0.001 to 0.03
Mg	0.01 to 15	
Zn	0.01 to 2	0.001 to 0.05
Ni	0.001 to 3	0.001 to 0.03
Cr	0.001 to 1	0.0005 to 0.03
Ti	0.01 to 0.5	0.0005 to 0.01
V	0.005 to 0.3	
Pb	0.01 to 0.5	
Sn	0.01 to 7	
Bi	0.005 to 0.5	

3 Ceramics Industry

Ceramics, cement, compounding feedstock, cement clinker, glass, bricks, clay, limestone

Cement, ceramics related

(%)

Sample Element	Couponding feedstock	Clinker cement	Limestone dolomite	Clay, silica slag	Dust, gypsum, iron slag
SiO ₂	11 to 22	17 to 30	0.1 to 40	38 to 100	0.1 to 20
CaO	38 to 48	50 to 70	25 to 60	0.1 to 45	17 to 50
Fe ₂ O ₃	1 to 6	1 to 6	0.1 to 4	0.1 to 15	0.1 to 90
Al ₂ O ₃	1 to 5	17 to 30	0.1 to 5	0.1 to 35	0.1 to 13
MgO	0.1 to 2	1 to 5	0.1 to 22	0.1 to 8	0.1 to 10
SO ₃	0.1 to 2	0.1 to 5		0.1 to 4	3 to 60
K ₂ O	0.1 to 2	0.1 to 4		0.1 to 5	1 to 25
Na ₂ O	0.1 to 2	0.1 to 2			
Cl	0.001 to 0.2	0.001 to 0.2			
MnO	0.1 to 2	0.1 to 5			0.1 to 5
TiO ₂	0.1 to 2	0.1 to 5			0.1 to 5

Glass related

(%)

Sample Element	Soda glass	Borosilicate glass	Lead glass
SiO ₂	58 to 73	53 to 80	35 to 70
B ₂ O ₃	0.5 to 5	8 to 16	
Al ₂ O ₃	0.2 to 7	2 to 15	0.05 to 5
Fe ₂ O ₃	0.02 to 0.1	0.01 to 1	0.003 to 0.1
TiO ₂	0.03 to 0.5	0.01 to 3	0.02 to 2
CaO	0.4 to 10	0.02 to 20	0.02 to 5
MgO	0.05 to 4	0.1 to 2	0.02 to 3
BaO	2 to 12	0.5 to 3	0.4 to 8
SrO	0.03 to 11	0.03 to 0.5	0.09 to 0.1
PbO	2 to 4		10 to 60
Na ₂ O	3 to 17	0.1 to 7	0.04 to 10
K ₂ O	0.8 to 9	0.05 to 2	0.2 to 20

4 Chemical Industry

Additives in oils, catalysts Inorganic components in resins, fertilizers

Polymer materials, oils, chemical treatment liquids and catalyst related

Sample Element	Polymer material (solid)	Oil	Catalyst
Na	20 to 500ppm		
Mg	3 to 200		
Al	1 to 200		
S	0.5 to 200	500 to 30,000ppm	
Cl	3 to 200		
Ti	0.5 to 200	10 to 1000	
V	0.5 to 200	10 to 1000	
Ca		50 to 5000	
Ni		1 to 100	
Zn		20 to 10,000	
Pt			0.05 to 0.2%
Pb			0.05 to 0.4
Rh			0.009 to 0.04
Ba			1 to 3
La			0.5 to 2
Ce			1 to 3

Sample Element	Pigment
Co ₃ O ₄	20 to 30%
NiO	5 to 15
Fe ₂ O ₃	34 to 50
MnO ₂	2 to 6
Cr ₂ O ₃	15 to 25

Sample Element	Pharmaceutical products
As	0.5 to 20ppm
Pb	0.5 to 20
Bi	0.5 to 20
Cu	0.5 to 20
Cd	0.5 to 20
Sb	0.5 to 20
Hg	0.5 to 20

5 Agriculture and Food Feedstock

Plants, soil, fertilizer, food

Plants, soil, fertilizer related

(%)

Sample Element	Plants
Cu	0.0005 to 0.006
Mn	0.003 to 0.02
Zn	0.0005 to 0.005
Fe	0.005 to 0.02
P	0.01 to 0.3
K	0.07 to 1.5
Ca	0.05 to 1.5
Mg	0.02 to 0.5

Sample Element	Soil	Fertilizer
SiO ₂	30 to 55	
Al ₂ O ₃	13 to 20	
Fe ₂ O ₃	7 to 10	
CaO	0.7 to 5	
MgO	1.5 to 3	
Na ₂ O	0.5 to 2	
K ₂ O	0.5 to 1.5	
MnO	0.1 to 0.3	
P		10 to 25
K		10 to 20

6 Environmental Samples

Industrial wastewater, river water, seawater Airborne dust, deposited dust, industrial waste

Dust, wastewater related

Sample Element	Atmospheric dust	Bottom sediments	Waste water
Na ₂ O		0.1 to 10%	
MgO		0.1 to 10	
Al ₂ O ₃		0.1 to 20	
SiO ₂		1 to 80	
Fe ₂ O ₃		0.1 to 20	
ZnO		0.005 to 1	
Mn	0.4 to 5µg/cm ³		
V	0.1 to 0.6		
Pb	0.1 to 4		0.05 to 5ppm
Zn	0.5 to 12		0.05 to 5
Ni	0.1 to 35		
Si			2 to 40
Cu			0.05 to 5
Fe			0.05 to 5

High Level Data Processing

The data processing unit, which uses an IBM PC/AT compatible personal computer, performs all of the control, operation, and processing of data of the MXF-2400. The operation is all carried out through a personal computer. The available functions include control and operation of the instrument, calculation of concentrations, and filling of analysis data.

Quantitative Calculation

Various calculation methods are selectable; you can select the method that is most suitable for your sample type and purpose of analysis.

Quantitative Analysis	X-ray intensity measurement		
	Drift correction	$I = aI_0 + \beta$	a/β correction of X-ray intensity (kcps)
	Overlap correction Background suppression	$I = I_0 - K_1I_1 - K_2I_2$	Spectrum overlapping is corrected and background suppressed.
	Correction with internal standard (Ratio method)	$R = \frac{I_0}{I_r^n}$	The ratio of scattered X-ray intensity and element concentration is obtained.
	Calibration curve	$W_i = aI^2 + bI + c$	X-ray intensities are converted into concentration values.
	Correction for absorption and enhancement	$W_i = X_i + \sum K_{ij}I_j$ $W_i = X_i (I + \sum d_j W_j) \sum I_j W_j$	Correction is made for absorption, enhancement, and overlapping due to matrix effects.
	Presentation (Printout) of data	<p>I : X-ray intensity K : Coefficient α,β : Drift correction factors dj : Absorption/enhancement correction factor a, b, c, d : Calibration factors Ij : Overlap correction factor W : Element concentration j : Coexisting element i : Analytical element n : Ratio coefficient</p>	

Operation for Data Processing

All the operation is made via a personal computer. The operation is exceedingly easy. Shown below are some typical display images.

1 Menu

Large icon display makes for excellent operability.



2 Analysis Screen

The analysis screen mainly comprises three windows: sample name input, analysis schedule and result display. Just input the analysis group and sample name and click on the Start button to effortlessly perform analysis.

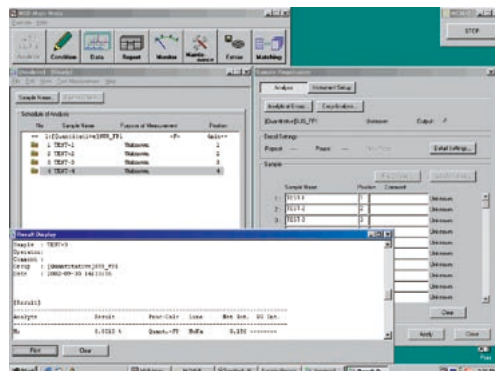

3 Handy Sample Registering

- In routine analysis there is no need to re-input a sample name once it has been registered along with the analysis conditions.
- Sample names can be simply input with consecutive numbers.
- Automatic operation possible by registering the device halt (standby) and start up in the schedule.

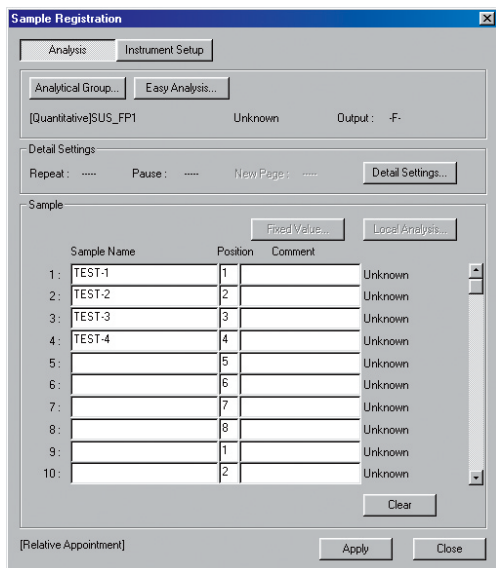

4 Network Function and Auto Mail Function

- Analysis results can be transmitted via LAN.
- Analysis completion notifications, analysis result transfer and error notifications can be e-mailed to specified addresses using the e-mail notification function.

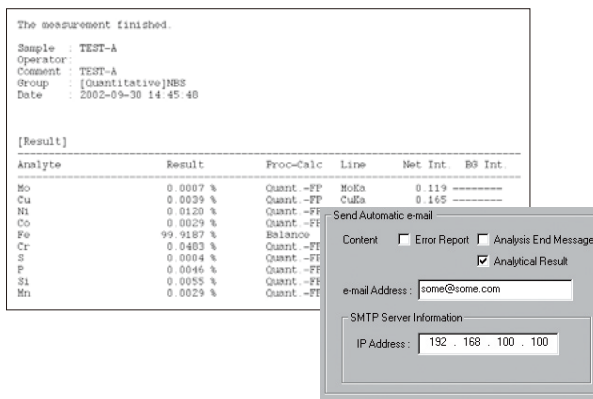

5 Self-Diagnostic Function

A self-diagnostic check corresponding to the alarm in question can be instantaneously displayed to enable speedy countermeasures.

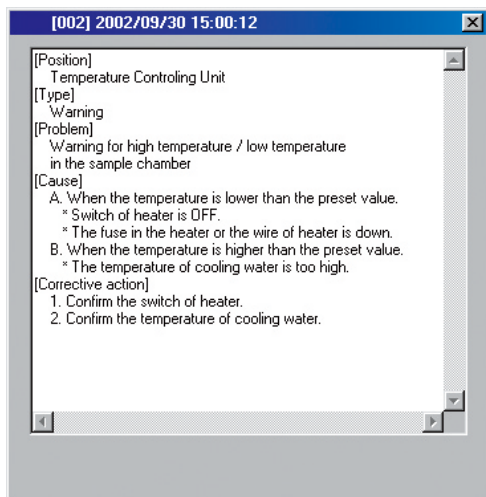

6 Report Function

Analysis results (quantitative and qualitative/ quantitative) can be easily compiled in daily and monthly report formats. Also editing is possible through the use of CSV output function to enable reading into spreadsheet software such as EXCEL.

Sample	Mo	Cu	Ni	Co	Fe
TEST-1	0.0011	0.0035	0.0069	0.0038	99.9196
TEST-2	0.0010	0.0045	0.0079	0.0020	99.9320
TEST-3	0.0010	0.0020	0.0103	0.0045	99.9152
TEST-4	0.0010	0.0045	0.0128	0.0026	99.9104
TEST-1	0.0011	0.0038	0.0101	0.0040	99.9315
TEST-A	0.0009	0.0045	0.0123	0.0021	99.9264
TEST-A	0.0007	0.0039	0.0120	0.0029	99.9187
test	0.0010	0.0034	0.0128	0.0042	99.9308

Sample	Cr	S	P	Si	Mn
TEST-1	0.0514	0.0005	0.0029	0.0075	0.0029
TEST-2	0.0375	0.0003	0.0028	0.0077	0.0029
TEST-3	0.0544	0.0004	0.0028	0.0053	0.0034
TEST-4	0.0549	0.0004	0.0043	0.0055	0.0036
TEST-1	0.0360	0.0005	0.0035	0.0071	0.0025
TEST-A	0.0404	0.0003	0.0035	0.0062	0.0024
TEST-A	0.0403	0.0004	0.0046	0.0055	0.0029
test	0.0360	0.0003	0.0038	0.0056	0.0020

7 X-R Administration Diagram (α-β Administration Diagram)

The change in analytical values over time can be displayed graphically to enable observation of whether or not analysis values have stably entered the specified range.

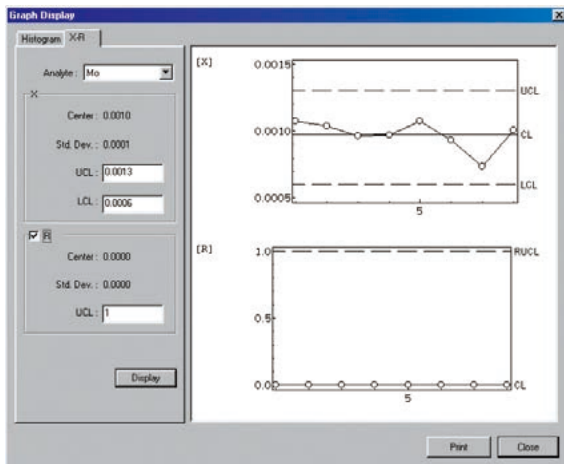

8 Automatic Operation System

Unmanned operation is possible through the use of functions such as a timer to automatically start up the system and halt it (put it on standby) after analysis is completed.

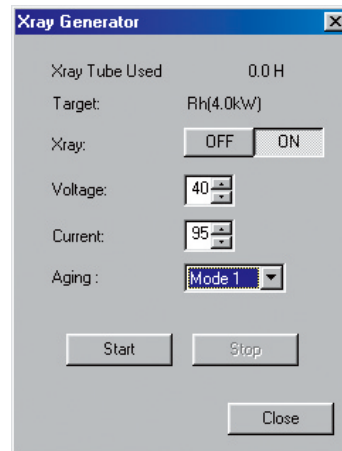

9 Calibration Curve

The optimal calibration curve coefficient is calculated by the method of least squares using the standard sample.

$$W = aI^2 + bI + c$$

W : Element concentration

I : X-ray intensity

a, b, c : Calibration constants

As well as being displayed in graph form, the calibration curve shows the calibration constants, precision and correlation coefficient, etc.

Graph display size also can be freely expanded and reduced.

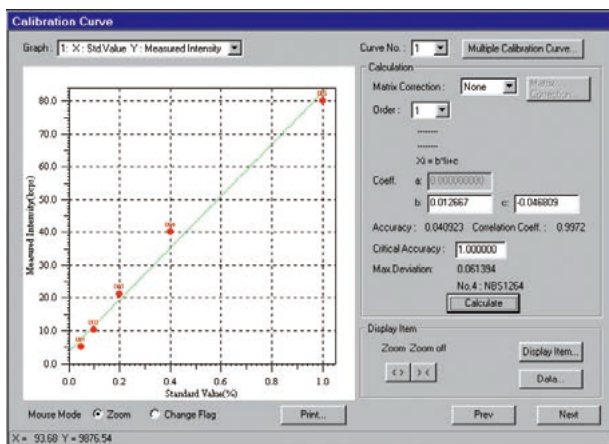

10 Matrix Correction

For samples with multiple elements, different measuring X-ray intensities will occur depending on the composition ratio of the main components, which may cause analysis errors. Analysis precision is enhanced if matrix correction is used.

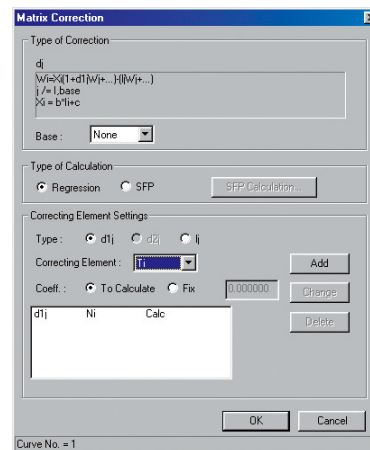

11 Qualitative Analysis

The scanner is used to perform qualitative analysis and the profiles will be displayed and can be printed out. Also, analysis result reports can be created with profile images if the data is combined with a tool like Word Pad.

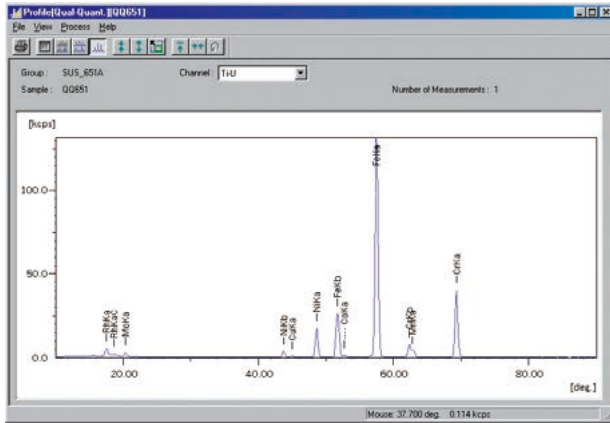

12 Quantitative Analysis Possible using FP Method

Quantitative analysis is possible with the FP method – which does not need a standard sample – using the scanner and fixed beam monochromators.

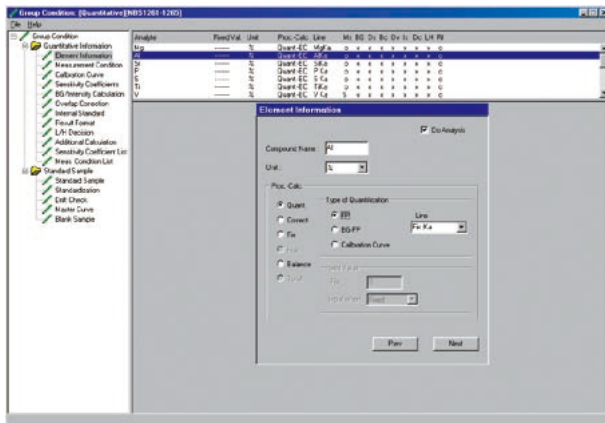

13 Four Types of Matching Functions

- 1) Impurity Judgment
Compares the unknown sample with standard sample values to judge whether or not it belongs to the same form.
- 2) Product Type Classification
Registers element standard values and tolerance of multiple forms to judge what form the unknown sample is.
- 3) Form Judgment
Registers the element content range for multiple forms to judge what form the unknown sample is.
- 4) Matching Search
Registers the standard values for multiple forms and searches for a match with the least differences between unknown sample and standard values.

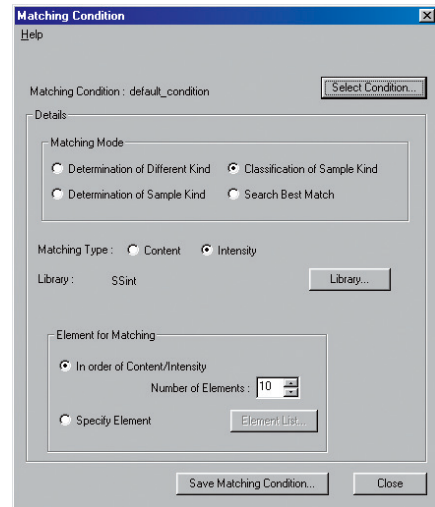

Specifications

1. X-ray Fluorescence Spectrometer

Elements to be determined: ${}^4\text{Be} \sim {}^{92}\text{U}$

Elements determined simultaneously: Up to 36 elements

Mode of analysis: Simultaneous determination of many elements

Atmosphere: Vacuum, air, helium (optional)

■ Spectrometer Unit

Fixed monochromator: Converging method with curved crystal.

Vacuum type for all the elements.

Crystal: SX, TAP, PET, Ge, NaCl, LiF

Detector: Gas sealed detector for ${}^{11}\text{Na} \sim {}^{92}\text{U}$

Ne, Ar, Kr exatron

Ne, Ar, Kr multitrion

FPC for ${}^8\text{B}$, ${}^6\text{C}$, ${}^8\text{O}$, ${}^9\text{F}$

Scanning monochromator (optional): Parallel beam method with flat crystal.

Used for heavy elements

Crystal: LiF

Detector: Scintillation counter (SC)

Elements to be determined: ${}^{22}\text{Ti} \sim {}^{92}\text{U}$ (with crystal for heavy element determination)

Present mechanism: Up to 30 elements may be preset

■ Measuring Electronics

Type: Pulse counting system for all the elements controlled with a microprocessor

Counting capacity: 4×10^9 counts/element

Counting method: integration for the preset time

Integration time: Adjustable for each group, from 1 to 999 seconds

High voltage supply for detector: 1,550 to 2,150 V

■ X-ray Generator

X-ray tube: End window type with Rh target.

X-ray window: Beryllium window (Thin Window)

Maximum output: 4 kW

X-ray power controller

Rectification: Full wave rectification and smoothing with a capacitor

Control method: Secondary side detection, primary side control, control with the CPU

Maximum rating: 50 kV, 100 mA, 4 kW

Stability: $\pm 0.01\%$ (for 10% source fluctuation), both the current and voltage

Tube voltage setting: 5 kV steps from 20 to 50 kV

Tube current setting: 50 kA steps from 5 to 100 mA

Safety circuit: Against overvoltage, overcurrent, overload, and abnormal cooling water supply

■ Sample Feeding Mechanism

Type: Accurate sample positioning with a swing arm type sample feeder

Turntable: Accepts 8 samples together

Spinner: 60 rpm (50/60 Hz)

Sample holder: 64 mmf, 43 mm high

Max. sample size: 51 mmf, 38 mm high

■ Evacuation System

Oil rotary pump:

Evacuation rate: About 130 L / 160 L /min. (50/60 Hz)

Oil mist filter provided

Vacuum gauge: Pirani gauge, constant temperature type

Vacuum stabilizer: Controlled with a microcomputer. The degree of vacuum can be stabilized at an arbitrary point.

■ Gas Supply System for Flow Proportional Counter

Use: Used of determination of B, C, N, O, and F

Gas: PR gas (Ar 90% and CH_4 10%)

Gas flow consumption: 10 to 15 mL /min.

Gas density stabilizer: Controlled by a microcomputer

Flow control: Needle valve and flow meter

Gas cylinder: A 6 Nm³ cylinder (If light elements (${}^4\text{Be} \sim {}^9\text{F}$) are attached)

■ X-ray Protection

Warning: Yellow lamp on the front panel and red lamp on the X-ray control panel.

Safety device: If the sample setter and the X-ray shutter are opened at the same time, the X-ray tube will be automatically turned off.

Also the moment the panel is opened the X-ray output is cutoff.

■ X-ray Tube Cooling Unit (CWC-16, incorporated in the main body)

Type: Circulation of distilled water (a 18-liter tank is attached.)

Method of heat exchange: Carried out in a dual tube between external cooling water and the distilled water.

Heat exchange capacity: 4 kW (3,440 kcal / hour)

Water purity maintenance: By ion exchange

Alarm: Temperature, flow rate, and electric conductivity

External cooling water: Necessary (Not necessary if using HYCOOL 30)

2. Data Processing Unit

■ Hardware (IBM PC / AT compatible)

OS: Windows XP

Main Memory: 256MB or more

Keyboard: Full keyboard

Floppy disk: 3.5" double-sided, double density (1.44 MB / disk). Single drive.

Hard disk: 10GB or more

Printer: Laser printer

■ Software

Program for quantitative analysis

Maximum number of elements to be processed: Arbitrary number of elements

Maximum number of elements to be simultaneously determined: 36 per sample

Number of analysis groups: Arbitrary number of groups

Repeated analysis: Arbitrary number of times

Priority interrupt analysis: Possible, automatic return to sequential analysis

Printout: Printout order can be specified for each group. Compound names and element names may be printed out. Pass and fail marks may be printed out.

Number of calibration curves: Per each group, per each element

Type of calibration curve: Second-order polynomial

Correction for dead time

Correction for absorption and enhancement: Per each group, per each element

Maximum number of elements to be corrected for absorption and enhancement:

Arbitrary number of elements per equation

Correction for drift: 2-point method or 1-point method

Correction for overlapping: 2-point method or 1-point method

Internal standard method: Available for each group or each element

Chemical correction: 2-point method or 1-point method

Number of calculation formula: Arbitrary channels for concentration calculation

Program for scanner: Arbitrary number of elements

Program for qualitative analysis

Scanner: For heavy element determination

Method: Step scanning

Method of processing: Automatic peak search and automatic peak element determination

Data output: On display and printer

Factor calculation

Calibration factor: By the method of least squares, up to second-order polynomial

Factor for correcting absorption and enhancement: By the method of multiple regression (concentration correction and sensitivity correction)

Maintenance program

Pulse height distribution: Graphic display

Monochromator alignment aid: Graphic display

Counter unit: Graphic display

Alarm: Display of alarm number, cause, and measure.

Manual instrument diagnosis: Parts by part check is possible.

External transmission program: Analysis data may be transmitted externally, in qualitative analysis.

External transmission (analysis results, errors, etc.)

LAN and RS-232C (optional)

Automatic notification via e-mail possible

Optional Accessories for Sample Preparation

Sample preparation for X-ray fluorescence analysis

Type of sample	Sample	Treatment	Sample Holder	Purpose of treatment
Solid	Iron, cast iron Steel High alloy steel Ferroalloy	— Cut — Polish with emery paper	— Solid sample holder	Surface smoothing
	Copper alloy Aluminum alloy	— Cut — Lathe	— Solid sample holder	
	Amorphous substance	— Centrifugal casting — Polish/lathe	— Solid sample holder	
Power	Metal powder Chemicals High polymers Plants	— Grind — Briquet	— Solid sample holder	Density uniforming and surface smoothing
	Ceramic materials Ores Soils Deposits Oxides	— Grind — Melt	— Solid sample holder	Suppression of grain size effect and suppression of influence of matrix element
Liquid	Oil Water	— No treatment	— Liquid sample holder	(No treatment)
	Oil/water Water	— Drop on filter paper — Dry — Collect on ion exchange filter paper — Dry — Settle/concentrate on DDTC — Dry	— Solid sample holder with filter holder	Solidifying Concentrating and solidifying

T-100 Disk Type Vibration Mill

Used to mix or grind samples such as slag, cement, ore, glass, and ferroalloy.

Standard content	Mill main unit and timer
Power requirements	3-phase 200 V ±10 %, 50/60 Hz, 5 A
Dimensions	435 mm dia. × 558 mm high
Weight	120kg

Either of the following sample containers is additionally required:

- Sample container made of tungsten carbide (used for analyses with Fe as a target element)
- Sample container made of chrome steel (used for analyses without Fe as a target element)
- Order the container separately.
- Indicate the power supply cycle (Hz) required.



TI-100 Vibration Mill

Used to mix or grind samples such as slag, cement, ore, glass, and ferroalloy.

Standard content	Mill main unit and timer
Inner volume	10 mL × 2
Power requirements	Single-phase 100 V ±10 %, 50/60 Hz, 2 A
Dimensions	W580 × D620 × H400 mm
Weight	70kg

Either of the following sample containers is additionally required.

- Sample container made of tungsten carbide (Used for analyses with Fe as a target element)
- Sample container made of chrome steel (used for analyses without Fe as a target element)
- Order the container separately.



TR-1000S Automatic Bead Fusion Furnace

Effective for minimizing the effects of thermal history and mineralogical effects in ores, rocks, clays, and soils. Also useful for cement or ceramic engineering and for producing glass beads from iron ores and sintered ores.

Fusion temperature	1000 °C normally, 1100 °C at the maximum
Heating method	Electric furnace with automatic stirrer
Sample preparation time	7 to 15 minutes
Power requirements	3-phase 200 V ±10 %, 50/60 Hz, 22.5 A
Dimensions	W1215 × D800 × H1350 mm
Weight	About 460 kg

The following accessories are required for glass bead manufacturing.

- Platinum crucible with lid
- Tongs for crucible
- Crucible polishing unit
- Flux



Notes:

- Other: A high-frequency induction heating type or a gas burner type automatic glass bead preparation device is available.
- Some options with no P/N are listed as an example. Please contact your Shimadzu representative for more information.

MP-35H Briquet Press

Operation	Automatic
Press	Hydraulic
Maximum pressure	350 kN
Pressure setting	Arbitrary with a valve
Method	Place the sample in the cup or the ring and press it.
Press head	Plane type
Power requirements	3ø 200V ±10%, 50/60 Hz, 3 A
Dimensions	W500 × D500 × H1,210 mm
weight	240kg



Flat press head

Briquets samples using a cup or a ring.

Sample Polishing Machine (with dust collector)

Power requirements	3ø ±200V ±10%, 4A
Dimensions	W560 × D750 × H995 mm
weight	165kg
Endless polishing belt	915mm long and 100mm wide

(No.136) The following endless polishing belt set (10 pcs./set) is additionally required

- Zirconia No. 80 (Not applicable to determination of Al and Zr.)



Briquetting Cup (No. 9)

Used for briquetting power samples.

Materials: Steel, Aluminum

Dimensions: 39.7dia. × 11.3mm high



Cup



Sample produced

Briquetting Ring

Materials: Aluminum, Vinyl chloride resin

The vinyl chloride resin rings are used for silicate samples, while the aluminum rings are used for other types of samples, such as cement.

Dimensions: 35dia. × 5mm thick



Solid Sample Holder

P/N: 212-20890-01

Mask diameter	30mmø
Mask material	Stainless steel as standard;titanium and aluminum as optional.
Dimensions	64dia. × 38mm high
Maximum sample size	51mm in diameter and 38mm in height.



Sample holder for local analysis

P/N: 212-20890-02

Used when performing a local analysis. It is possible to use the same mask as the one used for the solid sample holder.

Mask diameter	30mm \emptyset
Mask material	Stainless steel (standard) (Optional) Titanium, aluminum, copper, etc.
Container dimensions	64 mm dia. x 43 mm high
Sample dimensions	51 mm max. dia. x 38 mm high



Mask for Solid Sample Holder

P/N: 202-89038-XX

Masks for solid sample holder, which is suitable for the sample size or analytical purpose, can be selected.

Mask diameter	5, 10, 15, 20, 25, 30, 35mm \emptyset
Mask material	Al, Ti, Ni, Cu, Zr, Mo, Stainless steel



Liquid Sample Holder (for air or helium atmosphere)

P/N: 202-86996-03

Holds a liquid sample, such as river water, factory waste water, general waste water, chemical treatment waste water, and plating solution, to be analyzed with an atmosphere of air or helium.

Material	inner container: Fluoro-resin outer container: Stainless steel
Dimensions	64dia. x 43mm high

- Mylar film
P/N: 202-86501-55 6 μ m 100 sheets / set
P/N: 202-86501-56 6 μ m 500 sheets / set
P/N: 202-86501-57 12 μ m 100 sheets / set
P/N: 202-86501-58 25 μ m 100 sheets / set
- Polypropylene film
P/N: 219-82019-05 73mm W x 92m roll



Liquid Sample Holder (for vacuum atmosphere)

P/N: 205-11179

Holds a liquid sample in vacuum during analysis. The irradiation surface is covered with beryllium to keep the liquid surface stable, hence high stability of analysis is ensured.

Mask material	Titanium as standard
Material	inner container: Fluoro-resin and stainless steel outer container: Titanium and stainless steel
Dimensions	64dia. x 43mm high is recommended

to use an outer container for each group of analyses, and to use more than one inner container for one outer container; this will enhance the analytical productivity.

Inner container: P/N: 205-15110

Mylar, 6 μ m thick (P/N: 202-86501-56), (500 sheets/set)



Spotting Filter Paper, Ion Exchange Filter Paper, and Holder

Drop a liquid sample on the filter paper, dry, and analyze.

Filter paper: P/N: 210-16043-50; 50 sheets/set

Drop a liquid sample on the ion exchange filter paper, condense, adjust its pH, and analyze. The ion exchange filter paper is available in three types.

Note: A filter paper holder (P/N: 205-15030) and a solid sample holder are necessary.



Holder
(P/N: 205-15030)



Filter paper
(P/N: 210-16043-50)



Ion exchange filter paper
(P/N: 210-16167-1~3)

Cooling Water Circulation Device

P/N S239-15049-02

This is an external air-cooled water supply device used to supply cooled water to the X-ray tube when a suitable tap water supply is not available.

Cooling capacity	5.3 kW (50/60 Hz) (Ambient temperature: 32 °C, cooling water temperature setting: 20 °C)
Cooling system	Forced air cooling, refrigerating system
Power requirements	3-phase 200 V \pm 10 % (50/60 Hz, 7.6/8.1 A)
Dimensions	W400 \times D850 \times H966 mm
Weight	100 kg (water tank empty, with casters)

Note: Install it at a reasonable distance from the main unit as considerable calorific power (about 4.5 kW) is generated.

- Use at an ambient temperature of 32 °C or less.



RKE1500B-V-G2-SP

Installation Requirements

Environment

Temperature: 18 to 28C

Humidity: 70% or lower

Vibration:

Displacement (single swing): 80μm or less

Frequency: 30 Hz or less

Space: 3 x 4 m or larger

Power requirements

Main body: Three phase, 200/220 V 10%, 60 A, 50/60 Hz

Data processing unit: Powered from the main body, as standard. When an independent power line is used, it shall be single-phase 100 V 10%, 3 A

Optional accessories: Require a power described on pages 18 through 20.

Grounding: 30 ohms or less; and independent grounding line is required.

Cooling water

Primary cooling water: For cooling X-ray tube. 18 liters (to be replaced every 4 to 6 months). To be poured into the tank of the X-ray tube cooling unit.

Secondary cooling unit: For cooling the primary cooling water and the high voltage generator. The water shall be tap water or high-purity industrial water.

Supply pressure: 0.15 to 0.3 MPa

Drain: Free flow

Flow rate/temperature: Refer to the following table

Temp(C)	Below 10	20	30
Flow rate (L/min.)	4	5.5	10

Faucet: 1/2" and 14 mmø hose nipple

Note: The secondary cooling water is not necessary when the HYCOOL30 is attached.

Gas

PR gas: 10 to 15 mL/min.

A 6 Nm³ cylinder (If light elements (4Be~9F) are attached)

Heat emission

Main body: 1,960 kcal

Data processing unit: 240 kcal

Dimensions and Weight

Main body: 1,130W x 1,160D x 1,672H mm, 600 kg

Data processing unit: 600W x 645D x 1,400H mm,

80 kg (including the table)

Note

Since X-rays are used in the MXF-2400, please check all local laws and regulations, in advance.

Laboratory

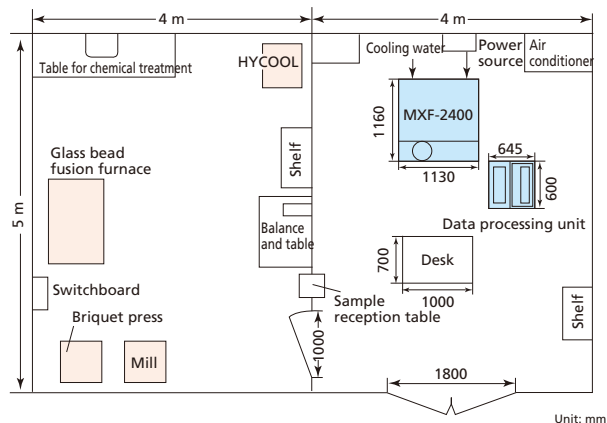

Unit: mm

Caution: Entrance size is required more than 1200^w x 1800^h mm.

Dimensions

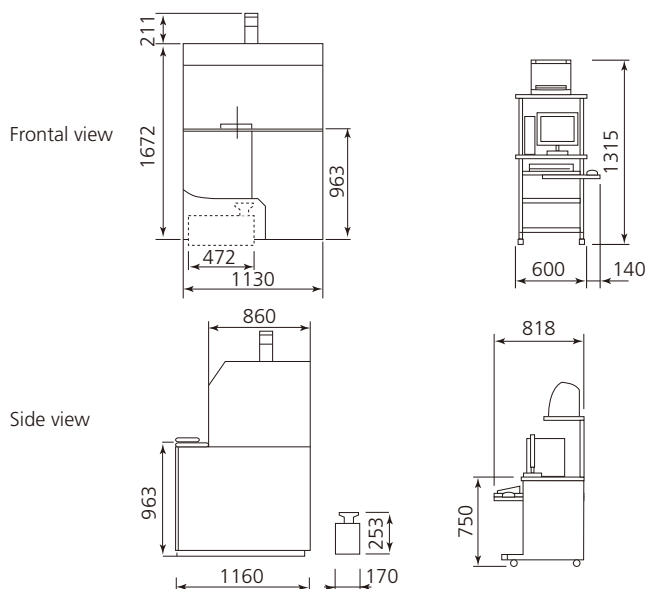

Unit: mm

Main body: 600 kg
Data processing unit: 80 kg

Necessary matters for safety are displayed by warning labels.

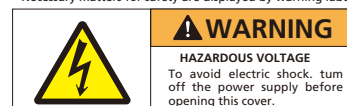

The contents of this catalog are subject to change without notice.



Shimadzu Corporation
www.shimadzu.com/an/

Company names, product/service names and logos used in this publication are trademarks and trade names of Shimadzu Corporation or its affiliates, whether or not they are used with trademark symbol "TM" or "®".
Third-party trademarks and trade names may be used in this publication to refer to either the entities or their products/services. Shimadzu disclaims any proprietary interest in trademarks and trade names other than its own.

For Research Use Only. Not for use in diagnostic procedures.
The contents of this publication are provided to you "as is" without warranty of any kind, and are subject to change without notice. Shimadzu does not assume any responsibility or liability for any damage, whether direct or indirect, relating to the use of this publication.