

Electron Probe Microanalyzer

EPMA-1720 Series



Revolutionary Fusion of Advanced Analytical Capabilities
with Superb Operability
Technology at the Pinnacle of Evolution Finally Arrives



Both hardware and software incorporate the latest technologies to create the next generation of EPMA. New functions that offer simple and easy-to-understand operation have been added to the superb basic EPMA performance that Shimadzu has fostered over many years—high sensitivity, high accuracy, and high resolution—to allow the EPMA capabilities to be exploited to the full. While easy enough for even novices to use, it also supports sophisticated analysis by experienced users.

Simple and Easy-to-Understand Operations Fully Exploit the Excellent Basic Performance Traditionally Offered by Shimadzu

High Sensitivity

High Accuracy

High Resolution

Simple, Easy-to-Understand Operation

Contents

P 04 - EPMA Basic Performance

P 07 - Features of the X-Ray Spectrometer

P 09 - High-Resolution Analysis

P 10 - Operation Flowchart

P 13 - Simple SEM Observation

P 16 - Analysis Display

P 19 - Observation Display

P 20 - Easy Mode Analysis

P 21 - Daily Maintenance

P 22 - Reliability

P 24 - Spectrometer Configuration

P 25 - Options

P 30 - Specifications

P 31 - Installation Requirements

Providing Solutions Based on High Basic Performance and Diverse Analytical Functions

Visible light observations on optical microscope images

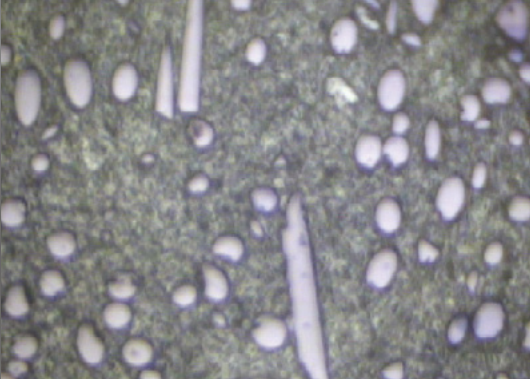

Shape observations over minute areas on SEM images

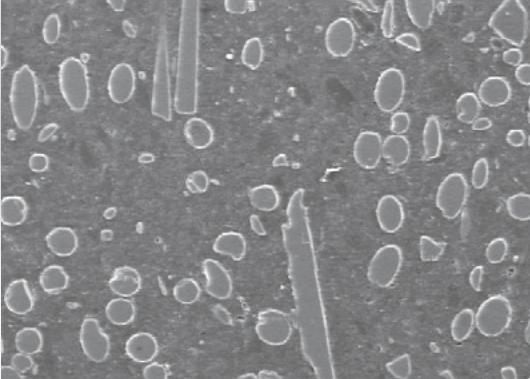

Composition distribution observations on BSE images

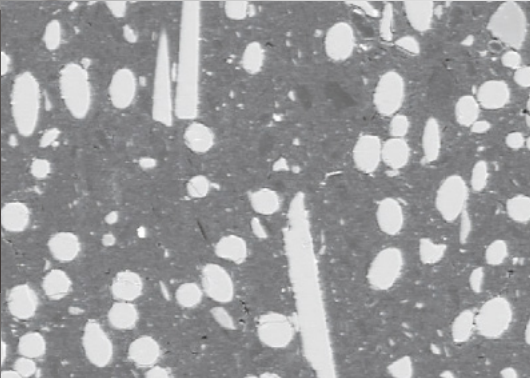

Qualitative analysis identifies the content elements

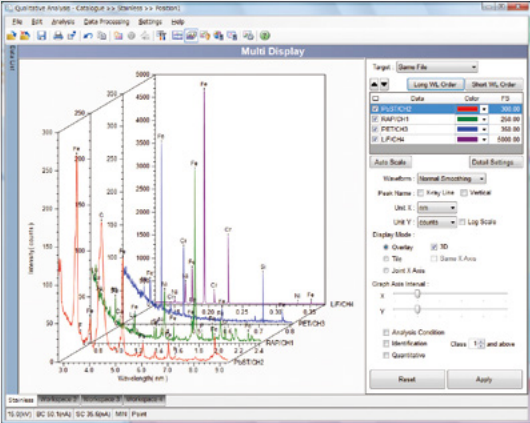

Mapping analysis identifies the element concentration distribution

Stage scan mapping

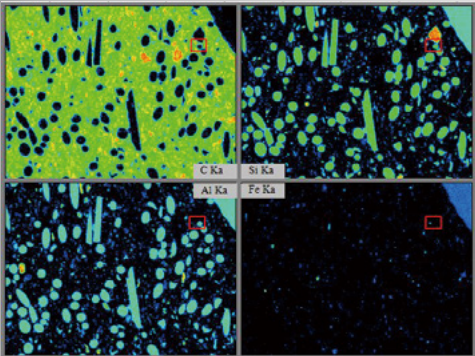

Beam scan mapping

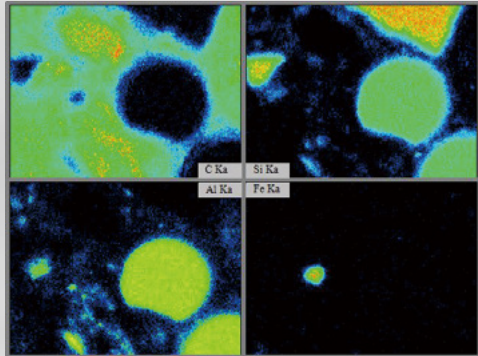

(Analysis of regions in red boxes in the diagram to the left.)



Line analysis identifies changes in element content

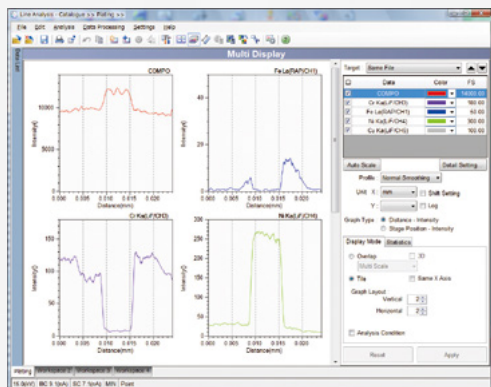

State analysis indicates the chemical binding status of the elements

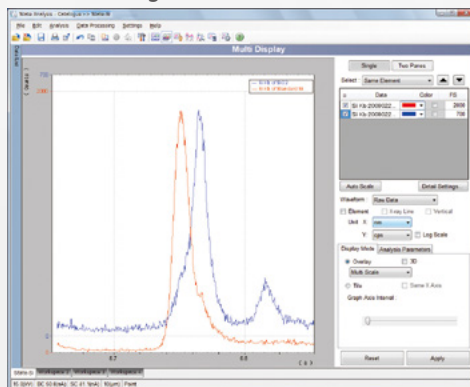

Quantitative analysis identifies the concentrations of the content elements

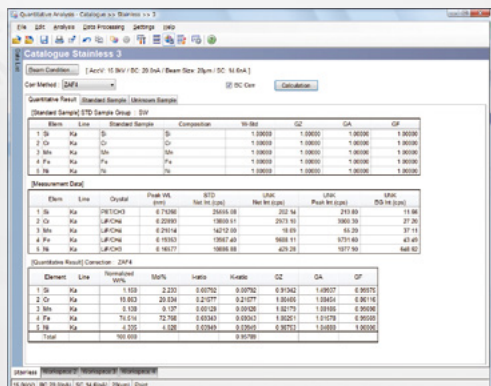

Calibration curve analysis identifies the trace element concentrations

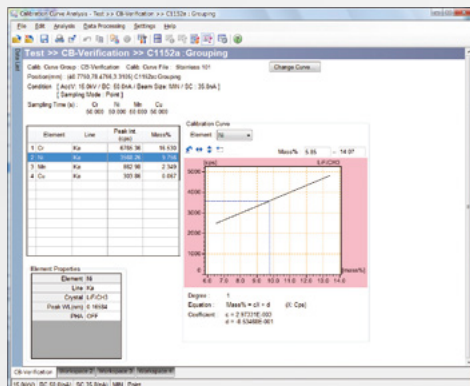

Wavelength dispersive X-ray spectrometers offer highly accurate analysis

Wavelength dispersive X-ray spectrometer (WDS) spectrum

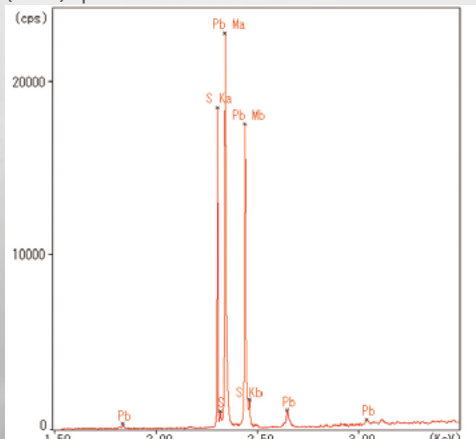

Energy dispersive X-ray spectrometer (EDS) spectrum

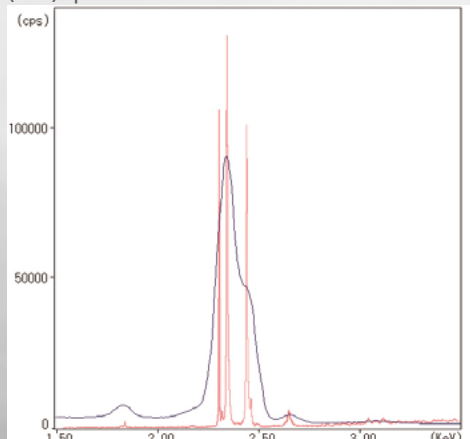

Due to high wavelength resolution and few overlapping peaks, WDS offers accurate evaluation of elements. Since it also offers a high S/N ratio, it is able to detect trace levels of elements.

High Sensitivity and Resolution

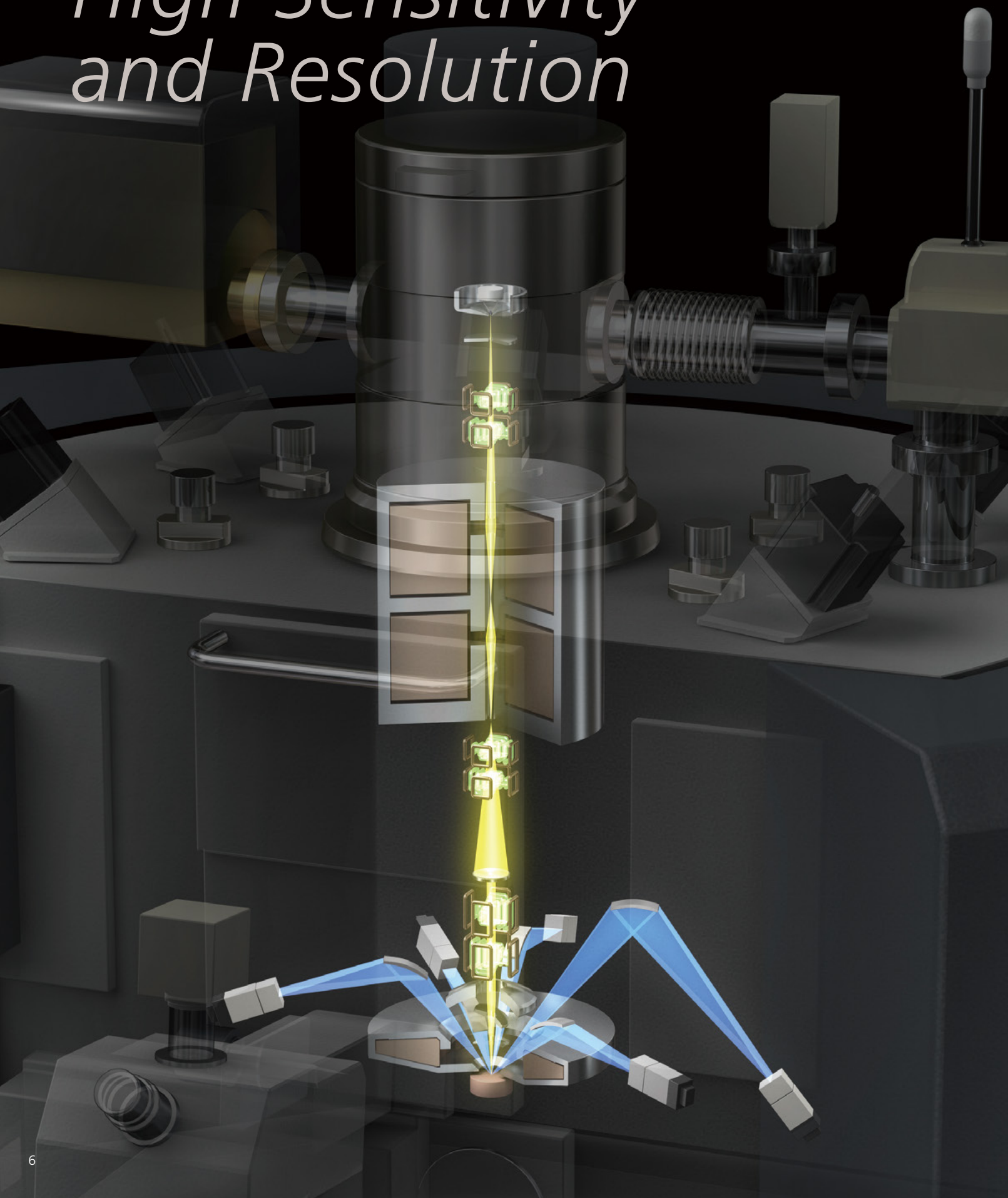

Optimum X-Ray Spectrometer Design Offers Highly Sensitive and Accurate Analysis

Maintains the 52.5° X-ray take-off angle that is fundamental to analytical performance.

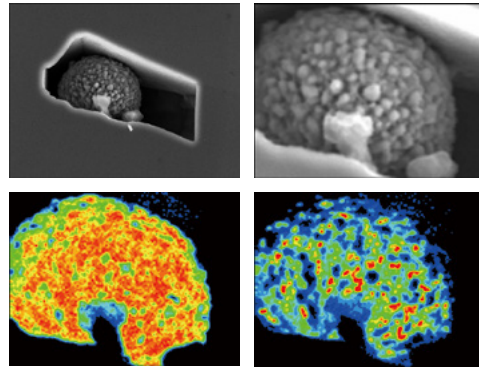
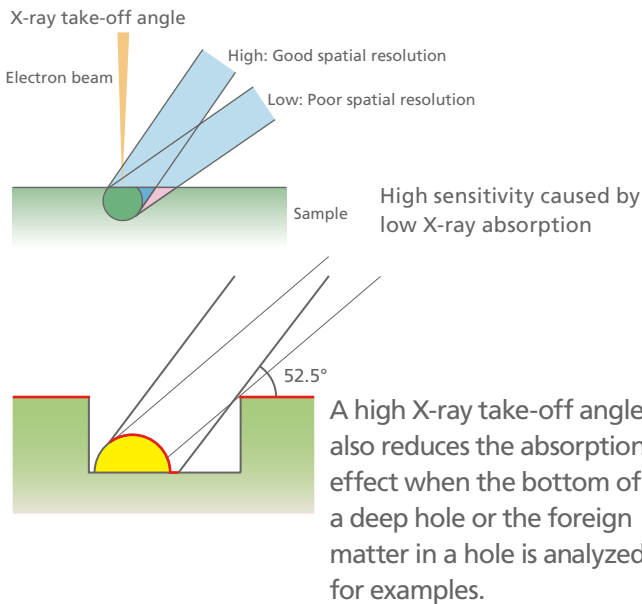

Analysis data for foreign matter in a pit. Bottom-left is the distribution of iron (Fe); bottom-right is the distribution of titanium (Ti). The high take-off angle used by the EPMA-1720 ensures highly accurate analysis of rough samples.

Johanson-type analyzing crystal achieves perfect convergence.

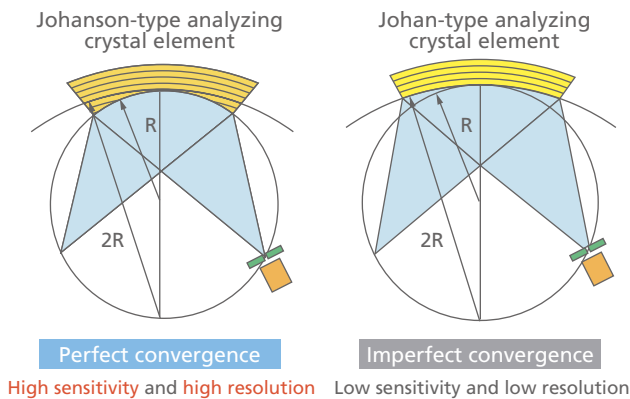

Shimadzu applied its unique crystal manufacturing expertise fostered through the company's long traditions to offer analyzing crystals that deliver both high sensitivity and high resolution. The Johanson-type analyzing crystal achieves perfect convergence with no aberration.

EPMA-1720 accommodates up to five 4-inch spectrometers that offer both high sensitivity and high resolution.

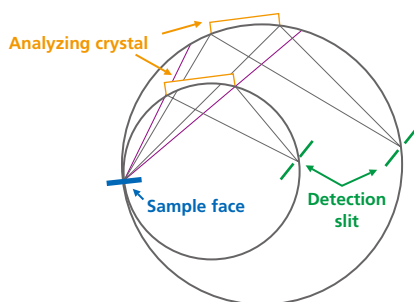

The Rowland circle radius in the X-ray spectrometer is an important factor affecting the EPMA analytical performance. Increasing the radius of the Rowland circle by one inch reduces the detection sensitivity by more than 30%. Shimadzu EPMA instruments accommodate up to five 4-inch spectrometers to cover the entire spectral range.

Excellent Reliability and Performance

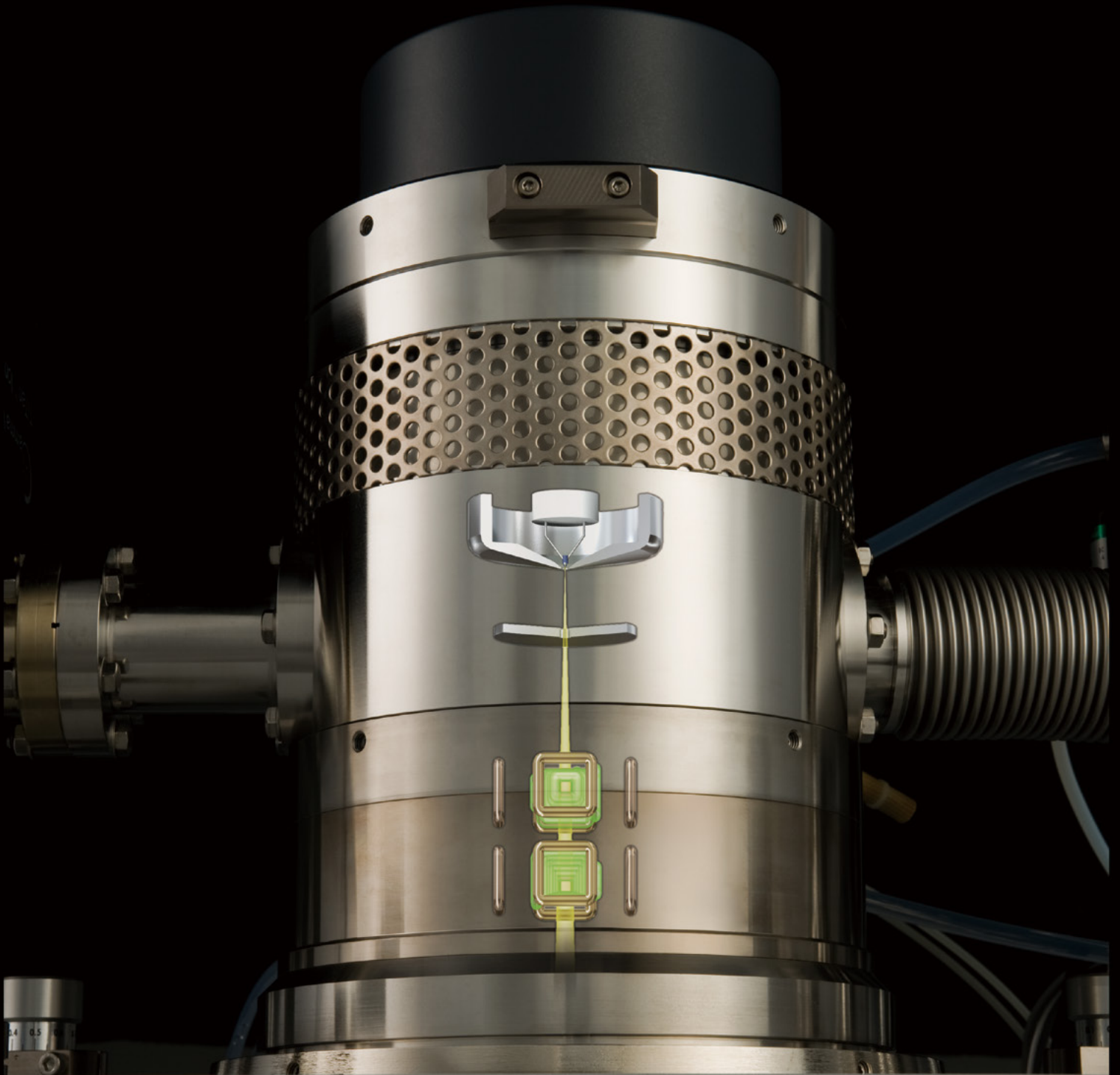

Fully Exploits the Performance of the High-Brightness Electron Source CeB_6

The CeB_6 cathode provides a bright, easily handled electron source. EPMA-1720HT fully exploits the properties of the CeB_6 cathode to achieve high spatial resolution that is stable over long periods.

* EPMA-1720T is for a tungsten filament only; EPMA-1720HT is for both a tungsten filament and CeB_6 cathode.

SEM Observation

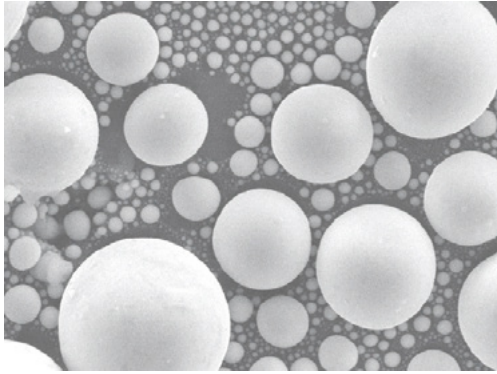
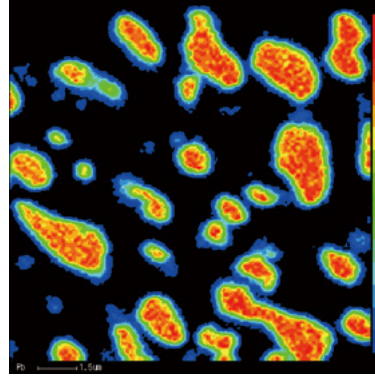

Image of Tin Balls
Magnification: 10,000x

Mapping Analysis



Analysis of solder
Element: Pb; region 14 x 14 μm

Differences Between Work Functions of CeB_6 and LaB_6

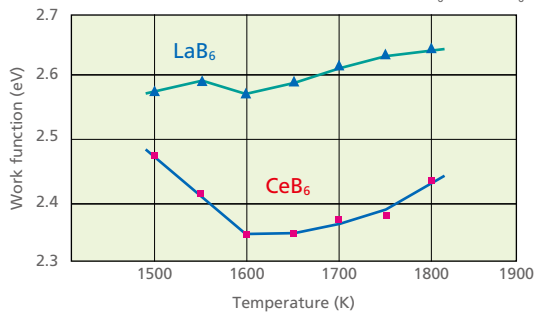

Since CeB_6 has a smaller work function than LaB_6 , it offers the excellent characteristic of producing highly bright emissions at lower temperatures.

Comparison of Evaporation Rates of CeB_6 and LaB_6

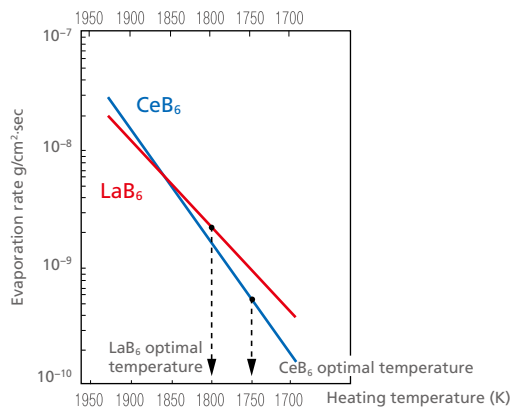

When CeB_6 is heated, it has a significantly lower evaporation rate than LaB_6 ; as a result, the CeB_6 has a longer service life.

Sample Mounting to Report Generation

Offers a simple, easy-to-learn operating environment for sample mounting, image observation, setting of analysis conditions, data analysis, and report generation. Anyone can learn to use the instrument in a short period of time.

1

Mount sample and load it into the instrument.

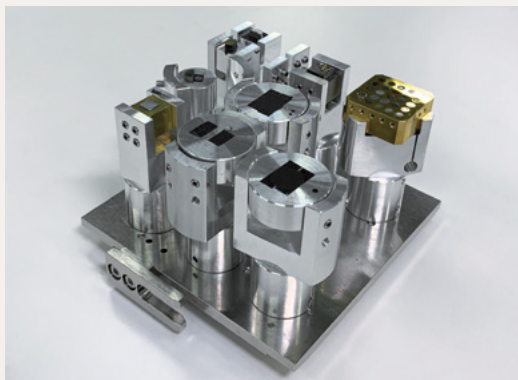

- Fasten the sample in the holder and mount the holder to the holder base.

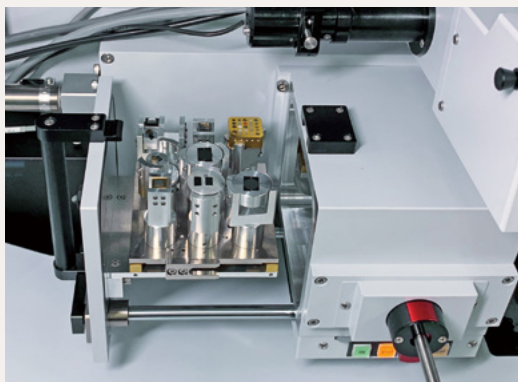

- Load the holder base in the sample loading chamber and close the cover.
- Press the [IN] button to start pre-evacuation. This process stops automatically when the set degree of vacuum is reached.
- Use the loading rod to insert the holder into the instrument.

2

Observe the image to confirm the analysis position, set the analysis conditions and start analysis.

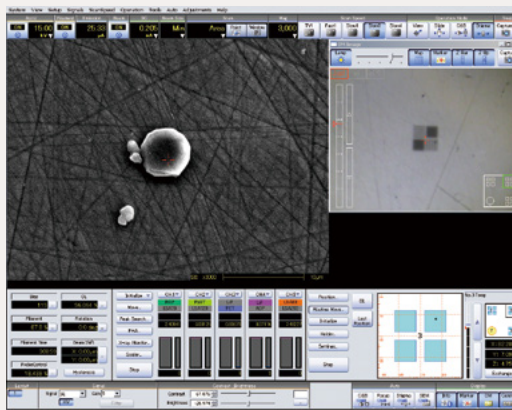

- Observe the image and determine the analysis position and other conditions in the observation window.

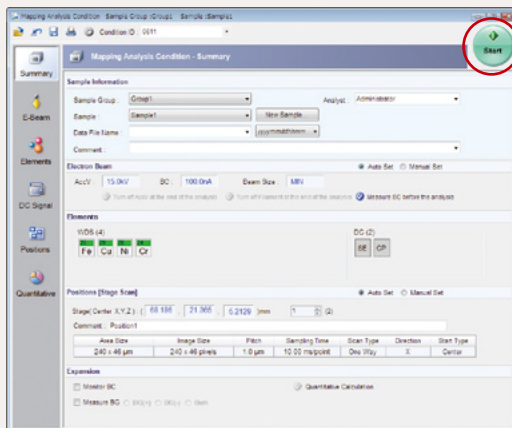

- Set the analysis conditions in the analysis window.
- Click the [Start] button to start the analysis.

3

When the analysis is complete, the system switches to the data analysis environment.

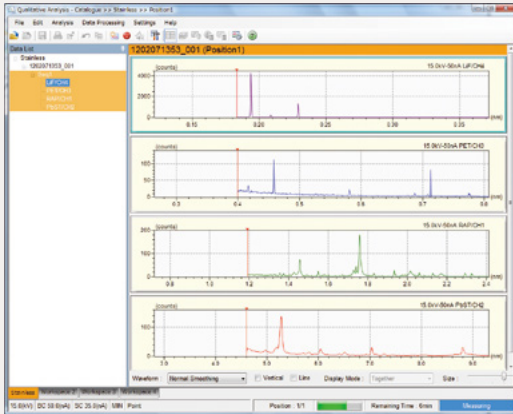

- During the analysis, the acquired data appears in real time in the data list window.

Data processing icons

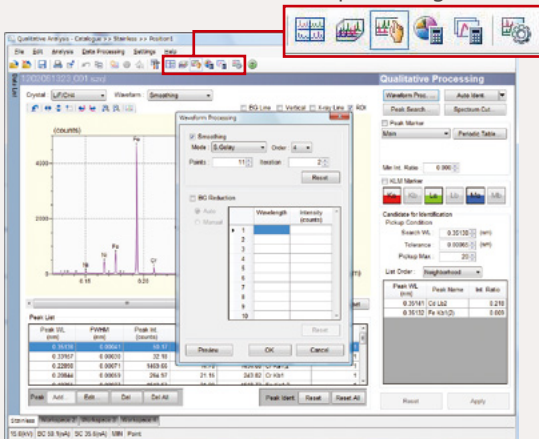

- When the analysis is complete, the data list window acts as the data analysis window.
- Click the required data processing icons to perform the data analysis.

4

Select the data in the data browser to generate the report.

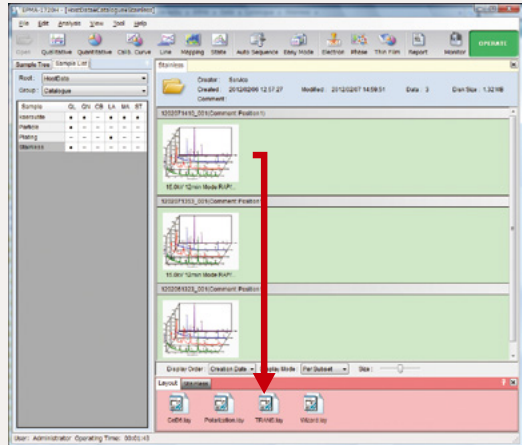

- In the data browser window, drag the data onto the template.

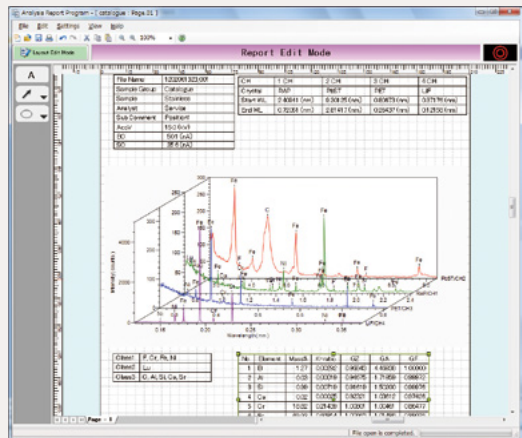

- The analysis report is automatically generated using the set data layout.

Innovations for Easy Operation



Sample Searching to SEM Imaging — So Easy a Novice Can Do It

Easy approach to the target position on the stage map representing the mounted holder

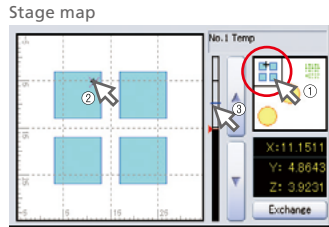

- (1) Select target sample holder
... Magnified image appears on the main map.
- (2) Double-click the sample position on the main map.
... Stage moves to the designated position.
- (3) Double-click the reference position on the Z-axis scale.
... The height is coarsely adjusted to the sample height.

The optical microscope image appears on the same monitor as the SEM image. The sensitivity is extremely high.

Observe on the same monitor as the SEM image

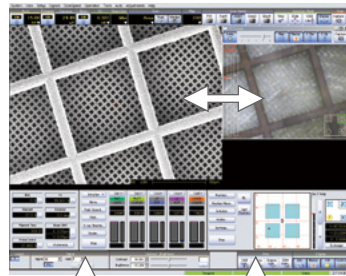

SEM image Optical microscope image

The SEM image and optical microscope image are displayed on the same monitor to minimize shifting of the operator's line of sight.

The high-sensitivity camera images even dark samples.

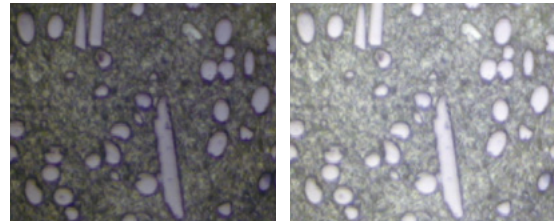

Optical microscope image with the naked eye Optical microscope camera image

Start SEM imaging with a single click.

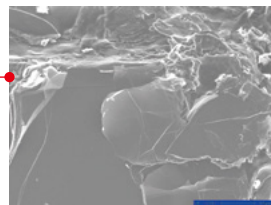

Just click the [Auto SEM] button to start SEM imaging using the preset conditions.

The auto contrast/brightness, auto focus, and auto stigma functions allow even novices to produce clear SEM images.



Auto contrast/brightness

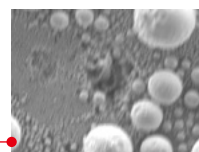
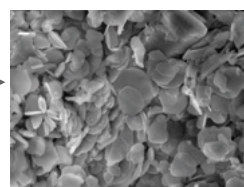

Auto focus, and auto stigma

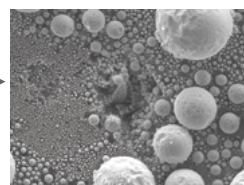

Quick and Accurate Response

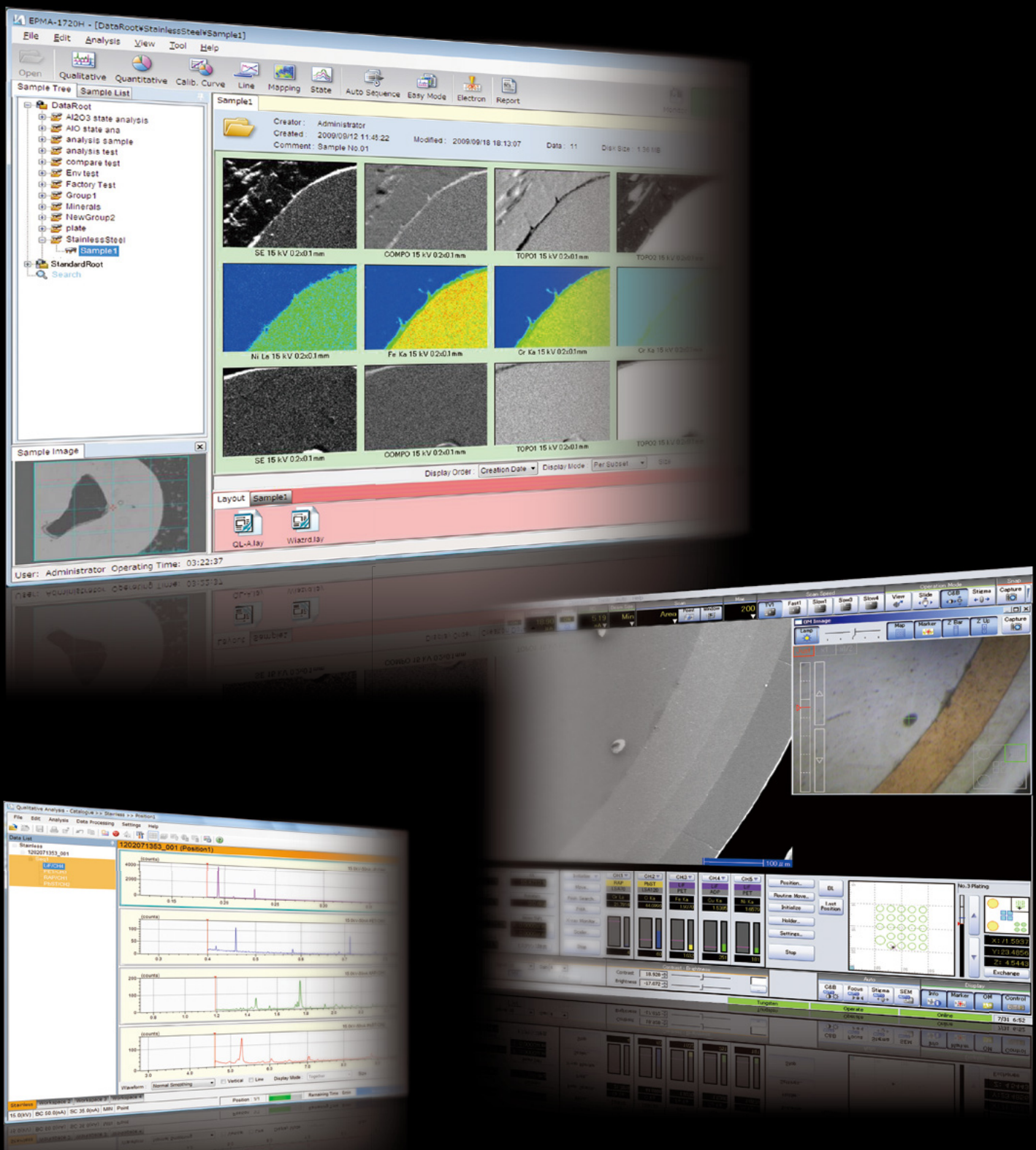

Unprecedented Easy Operation Boosts Work Efficiency Prior to Analysis

Dynamic operations using only the mouse. No other operating aid required.

Right-drag to focus.*

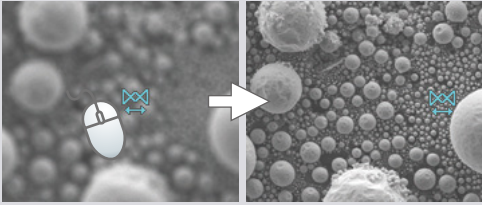

Move samples (like using a track ball).*

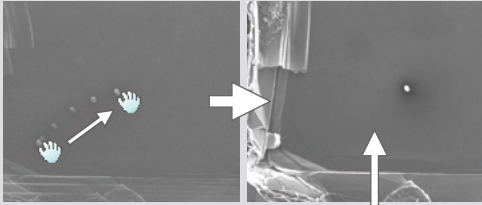

Sample moves with cursor position.

Double-click to center.*

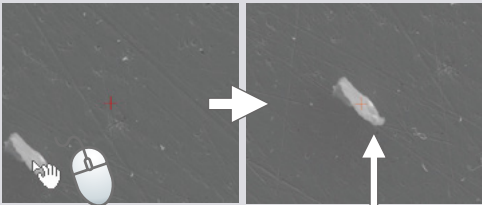

Designated position moves to the center of the image.

Move field of view (like using a joystick).*

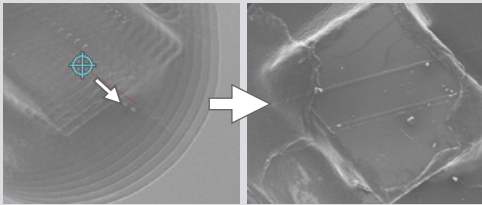

Field of view moves from center of screen toward the cursor.

* Perform operations on either the optical microscope image or the SEM image.

Simple, quick, and accurate adjustment of beam current, while maintaining focus

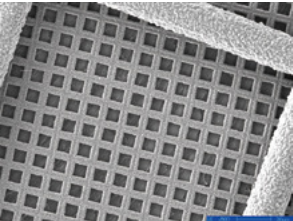

Sample current: 0.5 nA

⇒

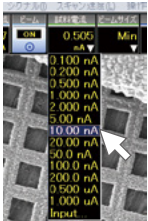

Select from menu

⇒

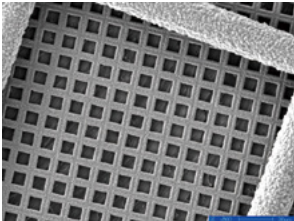

Sample current: 10 nA

Simply designate the target beam current for quick and accurate automatic setting. Interlocking control ensures that focus is maintained when the beam current is changed.

Clear BSE images even during rapid scanning

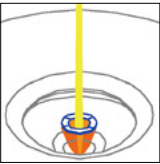

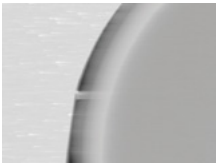

Conventional TV scan image

⇒

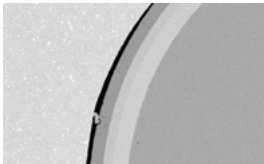

EPMA-1720 TV scan image

A newly developed 4-block semiconductor detector is used as the BSE detector. In Shimadzu's EPMA, the detector is uniquely positioned to enable high collection efficiency and achieve excellent response speed and sensitivity. It ensures clear BSE images even during rapid scanning.

User Interface with Easy-to-Understand Visibility

On analysis display, various analytical software and applications are available, and they are started by a data browser window that can display data files visually.

The data browser offers browsing and searching of acquired data as well as access to data analysis, new analysis, and report generation functions.

A new analysis starts here.

Simply select [Sample group] and then [Sample] to display thumbnails of the target sample data.

Drop data onto a layout file icon to generate an analysis report.

Double-click on a thumbnail to switch to the data processing environment.

Displays representative image of the sample acquired beforehand.

Analysis data is classified by sample, regardless of the type of analysis. Data for a single sample does not get scattered due to differences in the type of analysis.

The screenshot shows a software window titled 'EPMA-1720H - [DataRoot\StainlessSteel\Sample1]'. It features a menu bar (File, Edit, Analysis, View, Tool, Help) and a toolbar with icons for Open, Qualitative, Quantitative, Calib. Curve, Line, Mapping, State, Auto Sequence, Easy Mode, Electron, Report, and Monitor. A 'Sample Tree' on the left lists folders like 'DataRoot', 'A1203 state analysis', and 'StainlessSteel', with 'Sample1' selected. The main area displays a grid of thumbnails for various analyses: SE 15 kV 0.2x0.1mm, COMPO 15 kV 0.2x0.1mm, TOPO2 15 kV 0.2x0.1mm, Ni La 15 kV 0.2x0.1mm, Fe Ka 15 kV 0.2x0.1mm, Cr Ka 15 kV 0.2x0.1mm, and TOPO1 15 kV 0.2x0.1mm. A 'Sample Image' window shows a representative image of the sample. At the bottom, there are 'Layout' icons for 'QL-A.lay' and 'Wizard.lay'. A status bar at the bottom indicates 'User: Administrator Operating Time: 03:22:37'.

In addition to the SEM image and optical microscope image, the window controls all hardware operations, including the X-ray spectrometer and sample stage. In the observation display, all hardware controls including the X-ray spectrometer and sample stage are available in addition to the SEM image and optical microscope image. The user interface is designed to reveal the status of all hardware at a glance and offer intuitive operation. Frequently used functions appear on the front window for stress-free instrument operation.

Common functions for SEM observations are arranged on upper and lower toolbars.

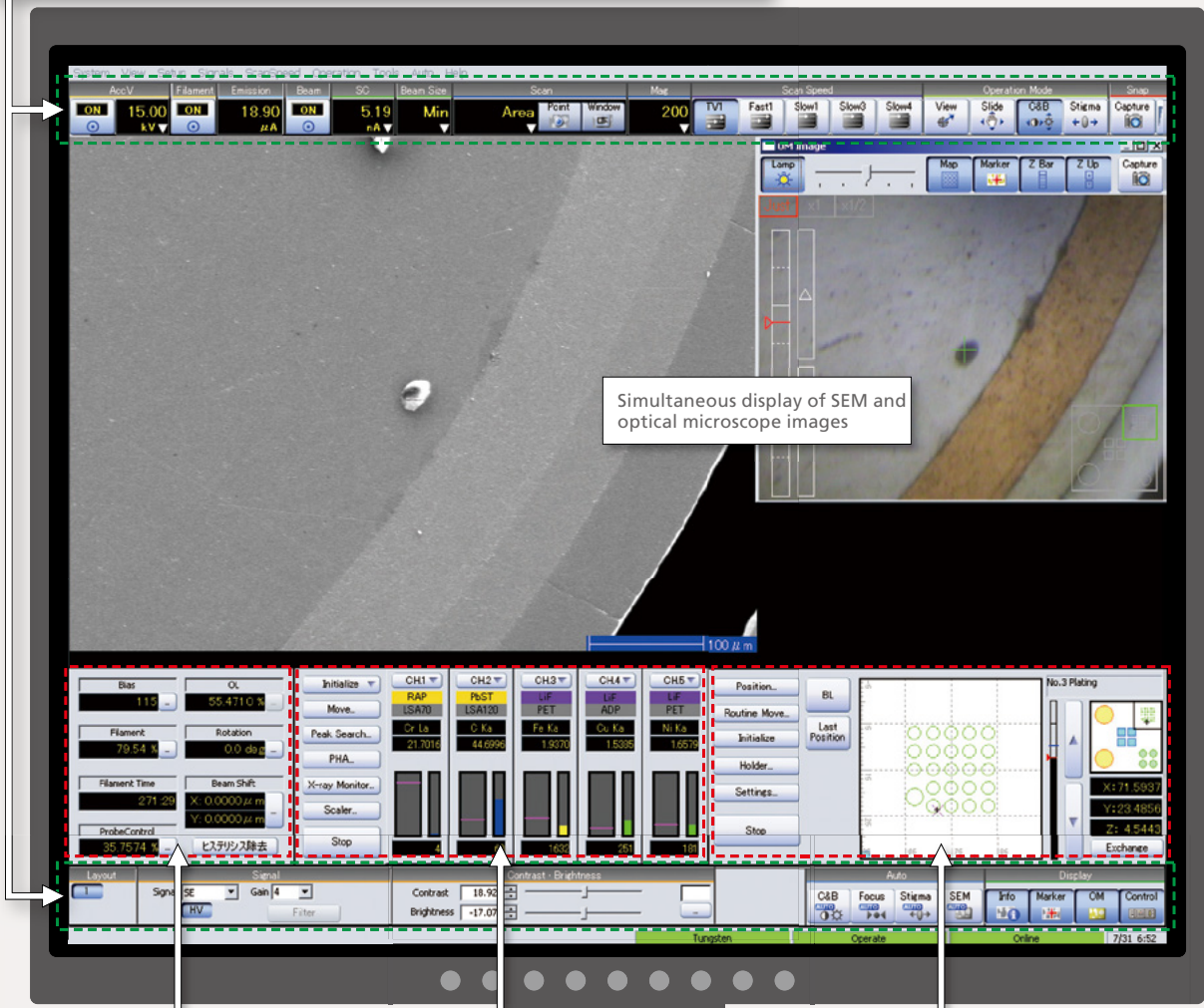

Simultaneous display of SEM and optical microscope images

Electron optical system control window
Offers detailed display and adjustment of the electron optical system settings.

WDS control window
Graphic display shows X-ray spectrometer settings for each channel at a glance. Controls are arranged for intuitive operation of required functions.

Stage control window
Simultaneous display of the overall map and enlarged map created according to the mounted holder allows accurate identification of the current position.

Analysis and Report Generation on an Easy-to-Learn Interface

Smooth operating environment

The operating environment allows even novices to smoothly switch between operations to run analyses, analyze data, and generate reports, without any confusion.

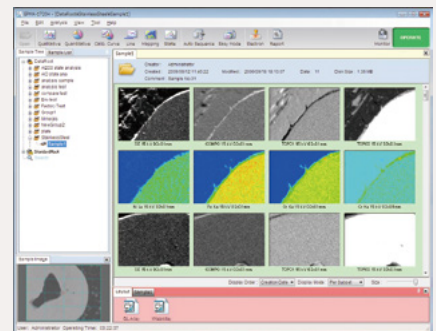

Host PC Window

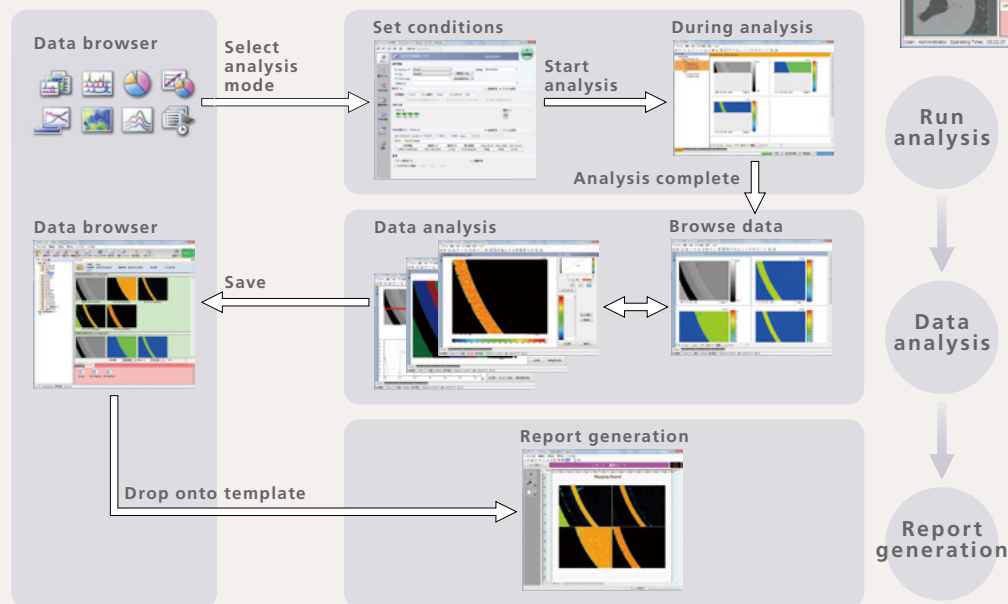

Make the settings you require—from basic analysis to applied analysis.

The analysis condition set-up function offers panel-type selection that allows switching between a summary display and detailed displays for individual items, making it easy to set basic conditions as well as conditions for applied analyses.

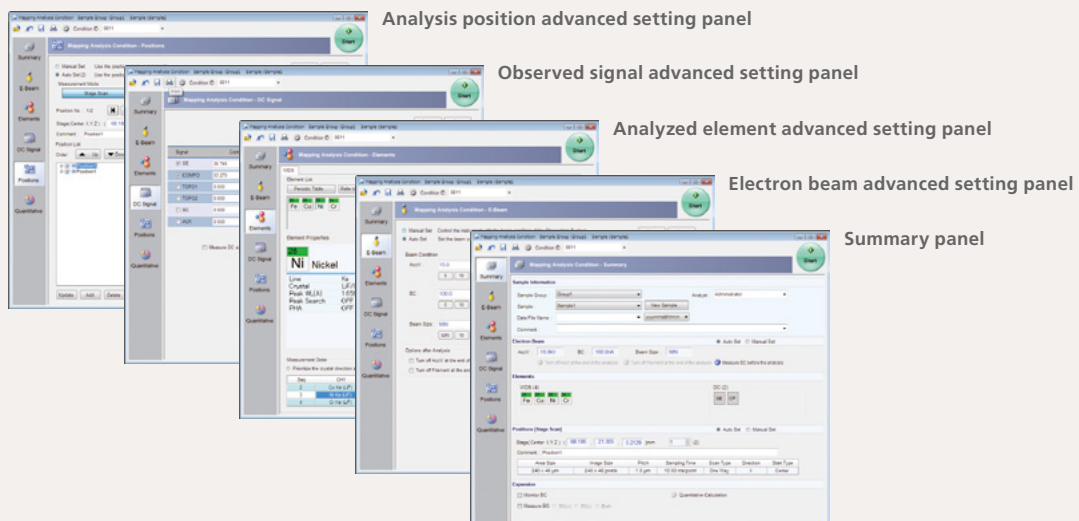

Easily run consecutive data processing operations.

Using the data processing icons to switch the data processing mode improves the efficiency of analysis tasks.

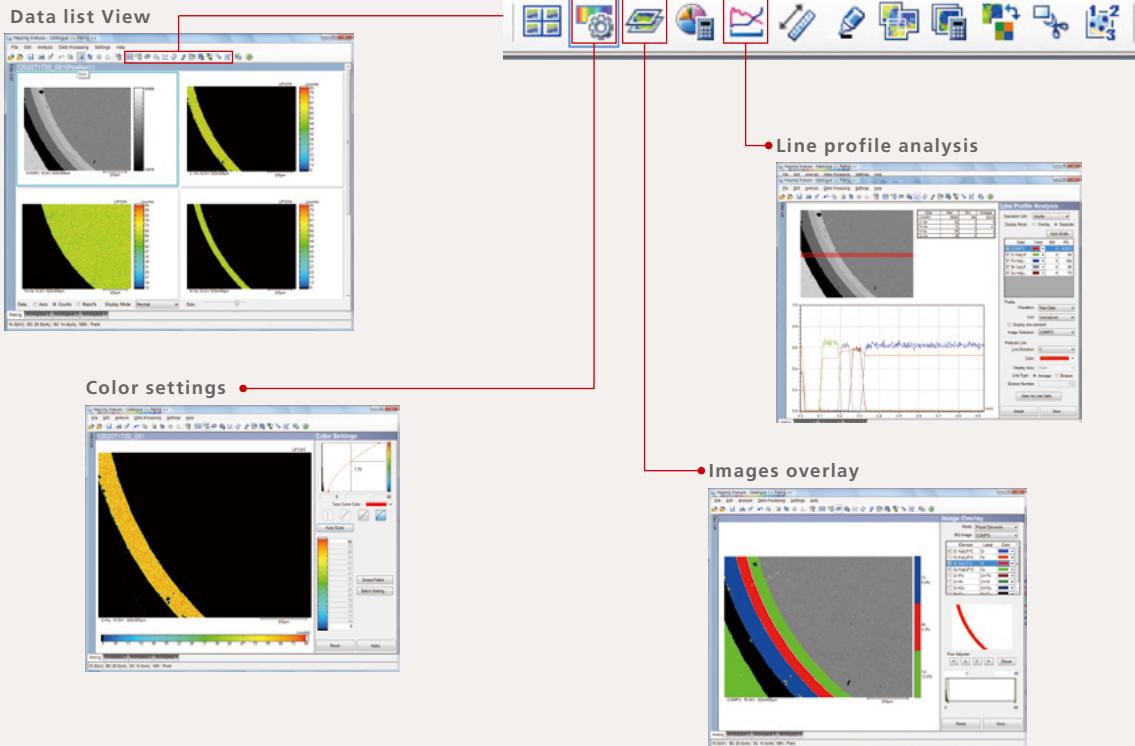

Paste data into templates for simple report generation

Analysis reports can be generated simply by dropping data onto a template. Templates can be created or edited to customize the report formats. Generated reports can be converted to MS Word file format and edited as necessary.

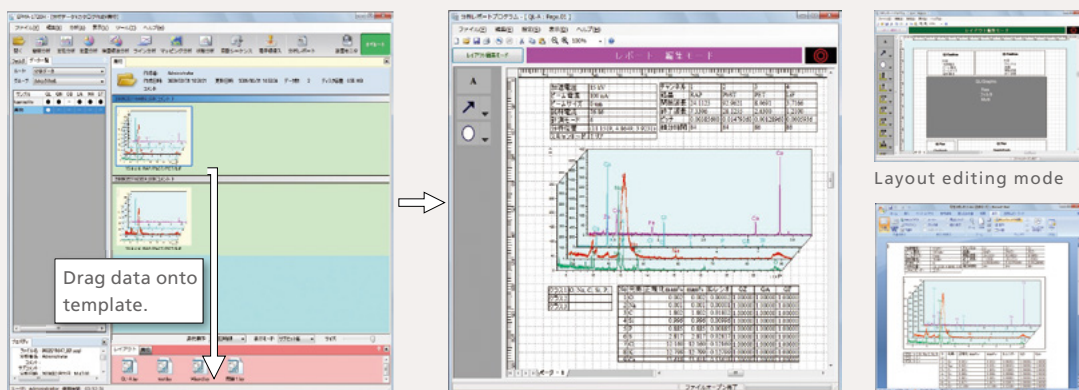

Easy Mode Analysis Automates All Processes Up to Report Generation

Select from three courses according to the target application.

Easy Mode Analysis executes a sequence of qualitative analysis, mapping analysis and report generation automatically with easy setup of conditions.

Select from three courses according to the target application and experience of the operator.

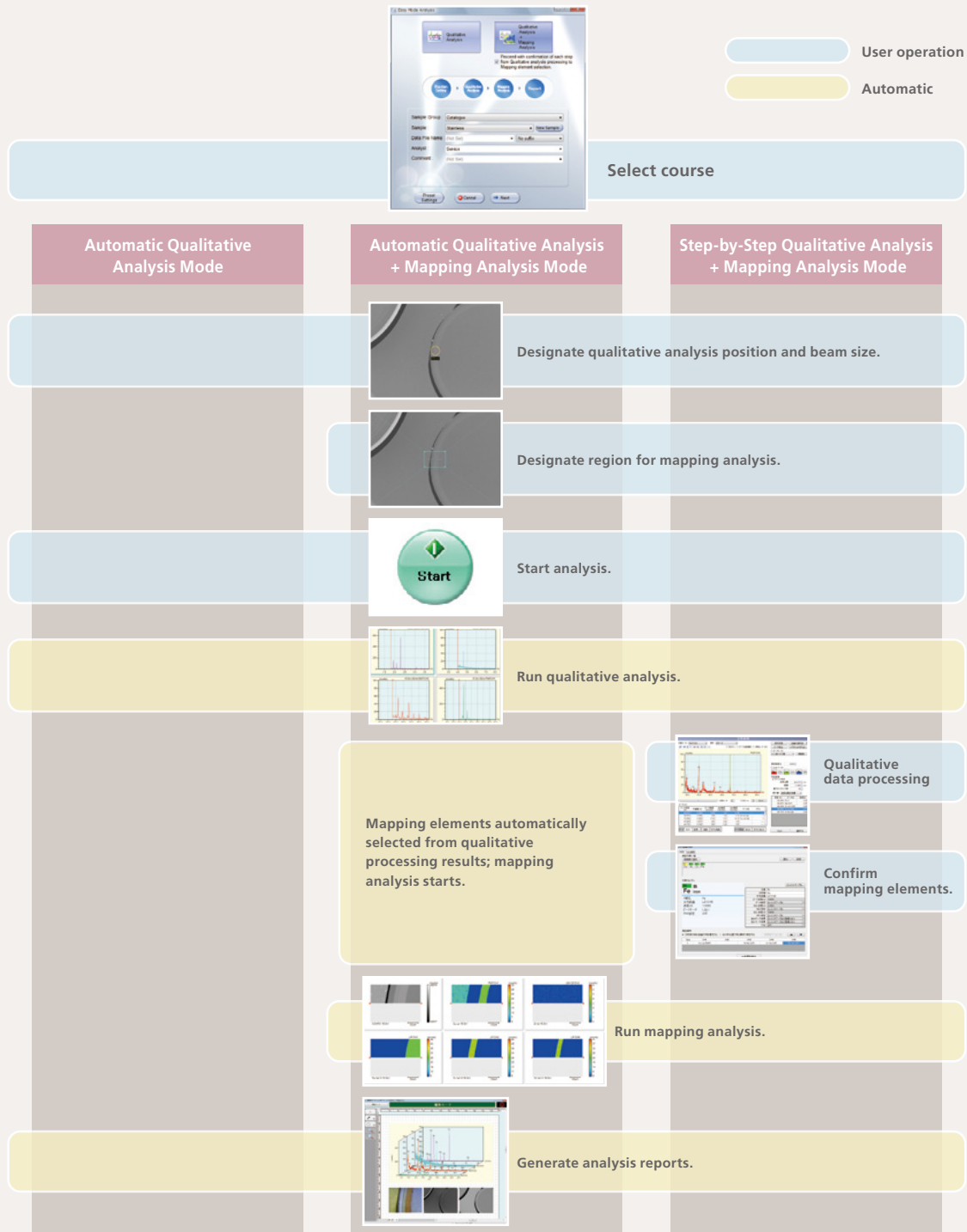

Daily Maintenance Is Easy

Simple filament replacement

Just assemble the filament with the Wehnelt and insert the assembly into the electron gun. So easy that anyone can do it.

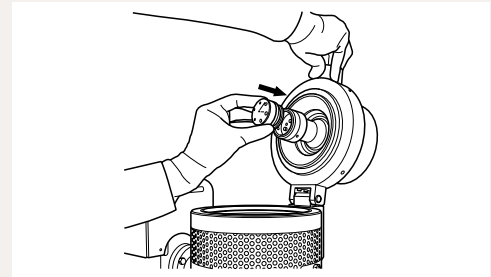

Axis-adjustment function with guidance lets anyone make the adjustment.

To adjust the electron beam axis, make mouse operations according to the guidance. Conditions for each acceleration voltage can be individually optimized.



Two automatic setting modes for the filament current

The optimal filament current value can be automatically determined and set. Two current adjustment modes are available: the beam current measurement mode for fine adjustments and the emission current measurement mode that offers coarse adjustment before making the beam axis adjustment.

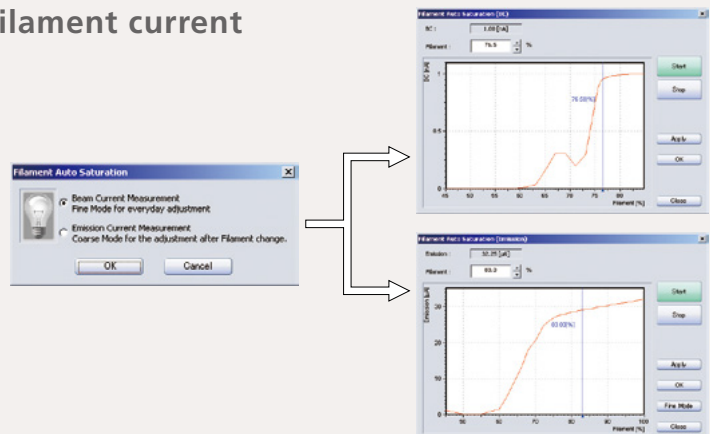

Graphic displays accurately indicate the instrument status.

The instrument monitor functions graphically display the instrument status for an accurate indication of the current status.



Easy CeB₆ cathode start-up

The baking and ageing processes required after replacement of the CeB₆ cathode run automatically under simple software control.

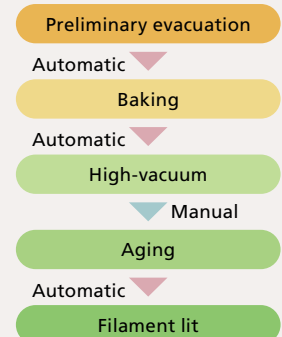

Continual, Detailed Enhancements Ensure Excellent Reliability

High-speed, submicron-step sample stage

The new sample stage offers high-speed 15 mm/s max. drive speed in 0.1 μm steps*. The precise movements and rapid speed, while maintaining highly accurate repeatability, considerably enhance work efficiency.

* 0.02 μm minimum steps during analysis

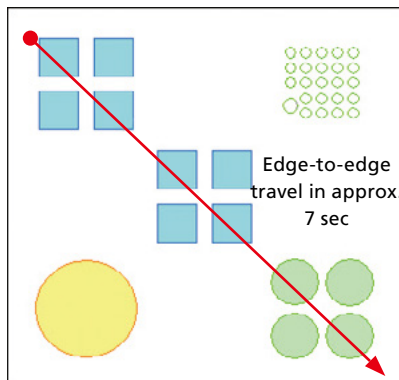

Comparison of Centering Results

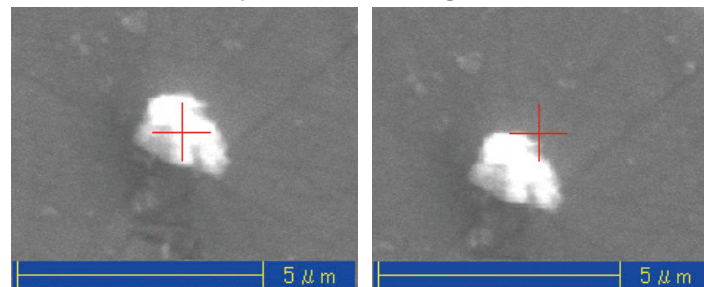

This example shows differences in accuracy for centering at the center of the particle.

Low-acceleration SEM observations

The beam axis can be optimized for each acceleration voltage, making it simple to take low-acceleration SEM observation. The acceleration voltage can be adjusted in 10 V increments to restrict charge build-up on non-conductive samples.

Observations of Non-Conductive Samples without Conductive Coating

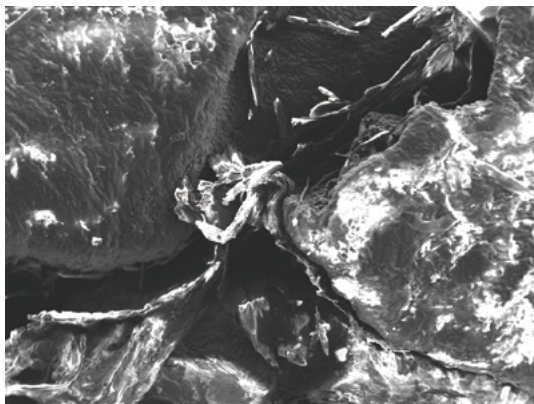

Acceleration voltage 15 kV

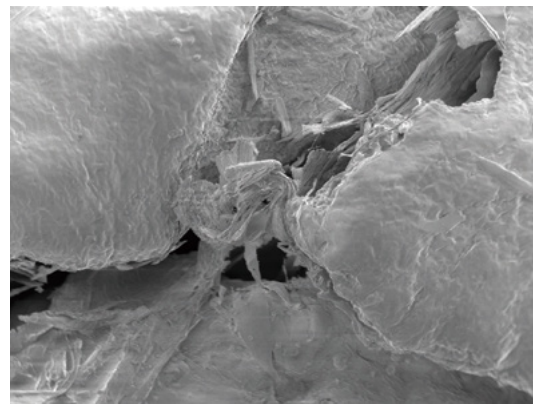

Acceleration voltage 920 V

User-management functions

Multiple login user names can be classified into different authority categories for user management. This protects the security of the system and analysis data when the instrument is shared with other departments or with multiple guest users.

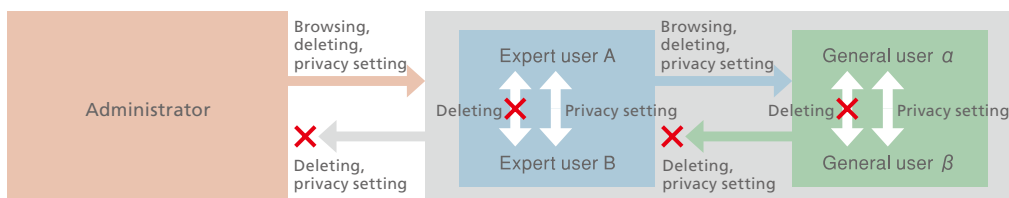

More evolved trace mapping system*

The trace mapping system maps the sample surface in real time while applying corrections for the height of the sample surface irregularities. The EPMA-1720 trace mapping system provides a better visual expression of the result of the curved surface approximation of the sample surface than previous systems. Enhanced responsiveness of the height correction operation achieves more accurate data, and supports the mapping of smaller regions, unlike conventional systems.

* Option setting

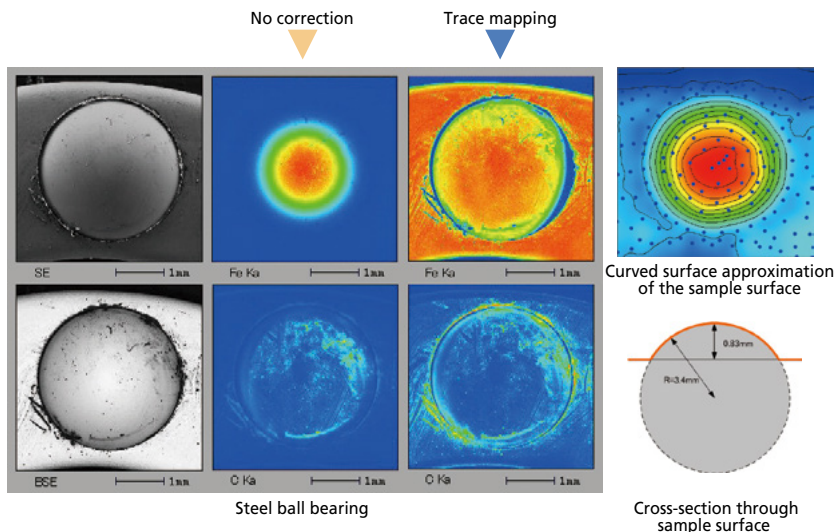

Beam adjustment mechanism offers perfect correction.

The axis adjustment mechanisms using a two-stage deflection coil are located at two positions, above and below the condenser lens. Setting optimal conditions for these mechanisms achieves a high-quality beam axis in all beam current conditions. It is not necessary to adjust the beam axis each time the beam current switches from the SEM conditions to analysis conditions.

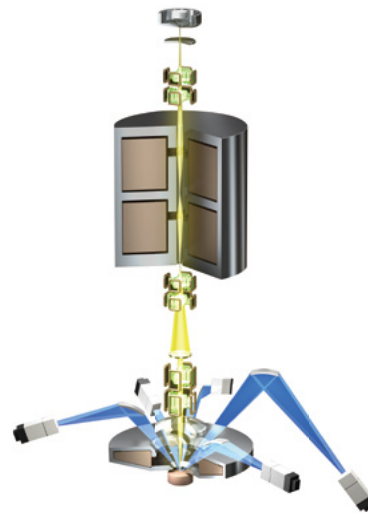

Intelligent evacuation system

The intelligent evacuation system incorporates a CPU and multiple sensors to allow continuous monitoring of the vacuum and operation status from any location and to provide accurate evacuation control. The graphical instrument monitor window shows the instrument status at a glance.

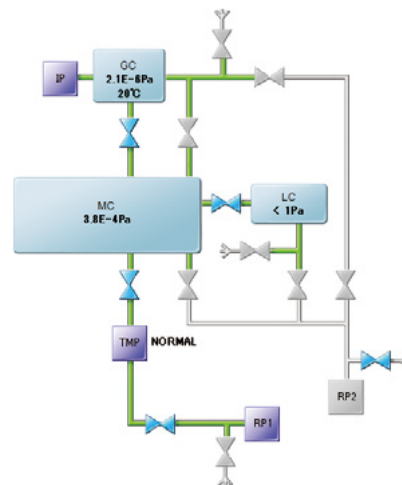

Spectrometer Configuration

Elements analyzable by each analyzing crystal and recommended spectrometer configuration

When multiple spectrometer channels are equipped, the optimal spectrometer element for the target must be selected from a large number of spectrometer elements.

Shimadzu's EPMA is designed to maintain optimal performance without replacing the objective aperture or otherwise changing the instrument parameters. The same philosophy was applied to the X-ray spectrometer, so that maximum sensitivity and optimal resolution are assured without the need to select the Rowland circle radius or replace the slit during analysis.

	Qualitative analysis	Quantitative analysis	Mapping/line analysis	State analysis
X-ray spectrometer providing good sensitivity and resolution (Shimadzu EPMA)	Supported	Supported	Supported	Supported
	* Only the Shimadzu EPMA spectrometer, which offers both good sensitivity and resolution, achieves optimal analysis conditions in all analysis modes.			
X-ray spectrometer emphasizing good sensitivity	Supported to an extent Peaks can overlap, causing incorrect evaluation.	Supported	Supported	Not supported More difficult to capture changes in wavelength.
X-ray spectrometer emphasizing good resolution	Supported to an extent	Not supported More difficult to reproduce peak intensity.	Not supported Greater sample surface effects; more difficult to maintain stable peak intensity over long periods.	Supported to an extent Difficult to detect small peaks.

Spectrometer Arrangement Diagram

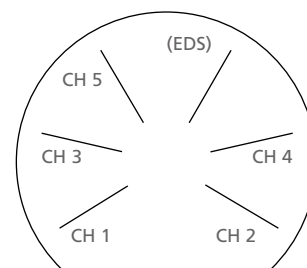

Types of Crystals

Crystal name	2d value (nm)	Detector	Comments
LiF	0.401	Kr-EXA	*
PET	0.874	Kr-EXA	*
ADP	1.064	Kr-EXA	
RAP	2.612	FPC	*
PbST	10.02	FPC	*
LSA55	Approx. 5.5	FPC	For high-sensitivity analysis of O, F
LSA70	Approx. 7	FPC	For high-sensitivity analysis of O
LSA80	Approx. 8	FPC	For high-sensitivity analysis of N
LSA120	Approx. 12	FPC	For high-sensitivity analysis of C
LSA200	Approx. 20	FPC	For high-sensitivity analysis of B
LSA300	Approx. 30	FPC	For high-sensitivity analysis of Be

Combinations of analyzing crystal marked * support analysis from ^8B to ^{92}U .

Examples of Analyzing Crystal Combinations

Spectrometer No.		2 Unit specification	3 Unit specification	4 Unit specification	5 Unit specification	
					Mainly heavy elements	Mainly light elements
CH 1	Main	RAP	RAP	RAP	RAP	RAP
	Sub	PbST	PbST	LSA120	LSA120	LSA120
CH 2	Main			PbST	PbST	PbST
	Sub			LSA70	LSA70	LSA70
CH 3	Main	LiF	LiF	LiF	LiF	LiF
	Sub	PET	PET	PET	PET	PET
CH 4	Main		LiF	LiF	LiF	LiF
	Sub		ADP	ADP	ADP	ADP
CH 5	Main				LiF	LSA120
	Sub				PET	LSA200

* No analyzing crystal combination is subject to sample stage drive range restrictions, option restrictions, or other restrictions.

Spectral Range of Analyzing Crystals

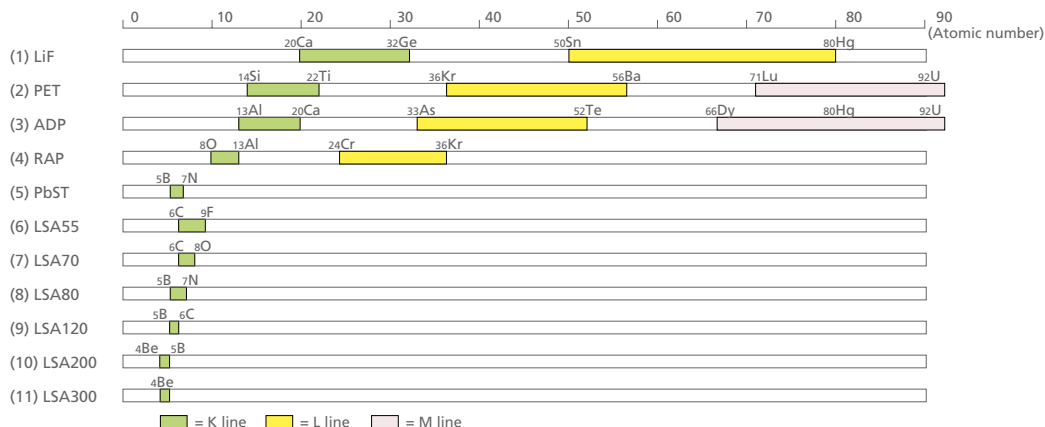

Options

Transmitted Polarization Observation System

With this option, some of the functions of a transmission polarization microscope, widely used in mineralogy and crystallography research, are achieved with an EPMA optical observation system. Rock flakes and other flaked samples are exposed to polarized light from below, and the transmitted light is observed with an EPMA optical observation system, enabling polarization observation. When samples are observed with a transmission polarization microscope already in the customer's possession, and are then observed or analyzed via EPMA based on the knowledge obtained, the observational functions of this product will be useful in searching for target positions. Observation and analysis can be performed using an electron beam while performing polarization observations.

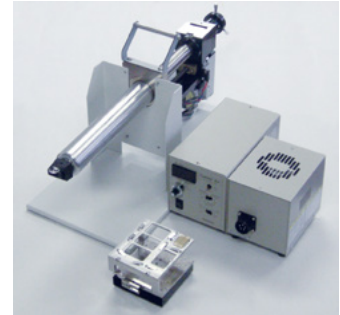

● Features

Observations can be performed in both open nicol and crossed nicols modes.

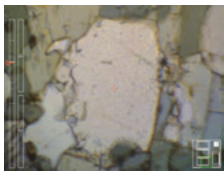

Sample Observation in Open Nicol Mode

In open nicol mode, light passed through a polarizing element (polarizer) is used to illuminate the sample from below. The transmitted light is then observed with the EPMA optical microscope. Mineral types are inferred by observing the boundary between neighboring minerals, and comparing refractive indices and studying the presence or absence of coloration.

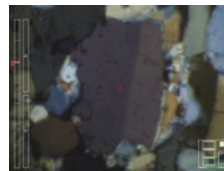

Sample Observation in Crossed Nicols Mode

In crossed nicols mode, observation is performed through a polarizing element (analyzer) configured to an angle orthogonal to the polarizer. Mineral types are inferred from interference colors that appear depending on the type and thickness of the mineral sample.

Polarization observations can be performed without rotating the sample.

With this system, the angle of the polarized light is changed by controlling the rotation angle of the polarizer and analyzer. As a result, observations can be performed without rotating the sample.

Sample Observations When the Polarization Angle Is Changed

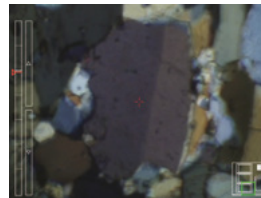

Polarization Angle: 85°

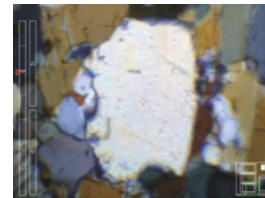

Polarization Angle: 113°

Collisions between the light guide and sample base due to improper operation are prevented.

When polarization observations are performed, the polarization observation sample base is used, and the tip of the polarization illumination optical path (light guide) is moved directly below the sample. When a standard sample base is used, the light guide tip is retracted to prevent collisions with the sample base. This system identifies the polarization observation sample base, and controls the stage and light guide accordingly, enabling it to prevent collisions due to improper operations.

The control window for polarization observations is linked to insertion of the polarization observation sample base.

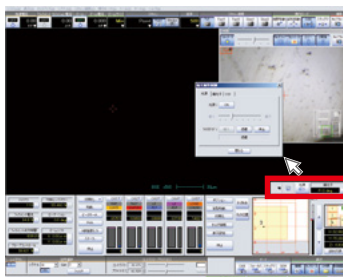

Window display is linked to the polarization observation sample base

Operational Windows in the Observation Window

The control window for polarization observations displayed on the PC is linked to insertion of the polarization observation sample base into the instrument. Operations following insertion of the polarization observation sample base can be smoothly performed.

The stage map for the polarization observation sample base can be used.

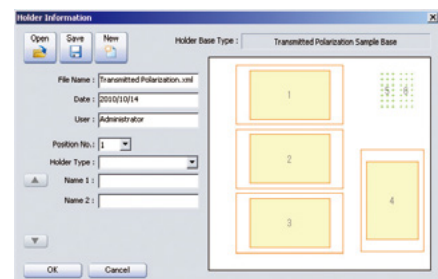

Stage Map Selection Window

The stage can be moved to the intended observation position utilizing the stage map corresponding to the polarization observation sample base.

Sample Rotation Stage Kit

The sample rotation stage kit is an optional system that enables using the sample stage as a 4-axis stage, moveable in X, Y, Z, and R-axis directions, by attaching a computer controlled sample stage equipped with a rotating mechanism (sample rotation stage) to the EPMA-1720 series sample stage. This allows using the computer screen operations to rotate the sample in any direction desired for observation and analysis.

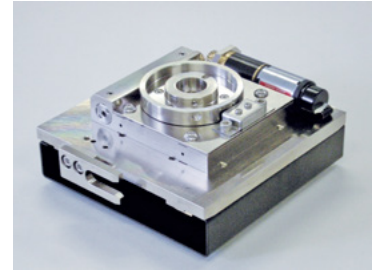

● Features

Allows displaying a stage map that changes depending on rotation angle.

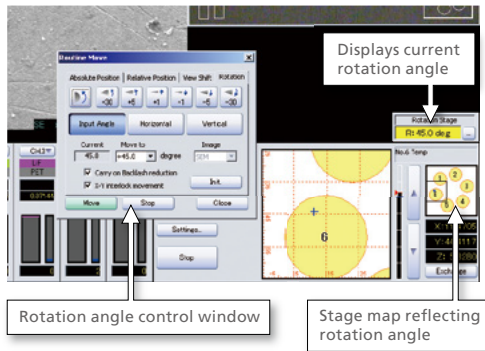

Since X-Y coordinate control is linked to rotation angle, rotation angle can be controlled without missing any observation angles*.

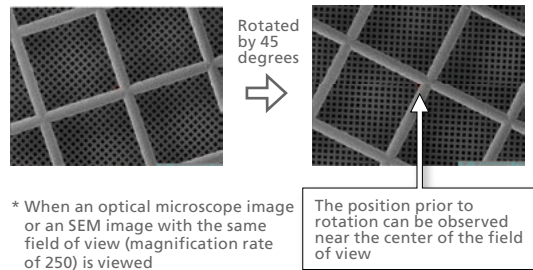

The stage can be rotated to orient any specified line on the observation image horizontally or vertically.

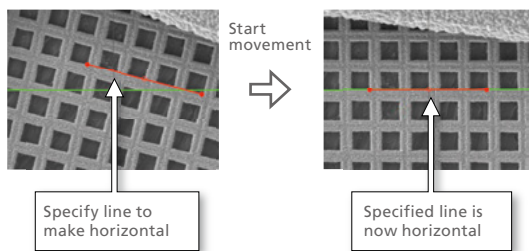

Rotation angles are recorded along with stage coordinates, and can be used for positional conditions in respective analysis modes.

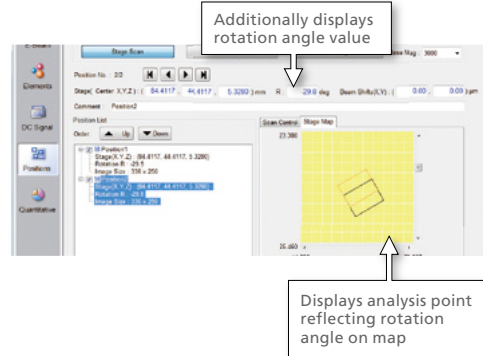

Six samples of 1-inch diameter can be placed simultaneously using the multi-sample stage and sample holders included.

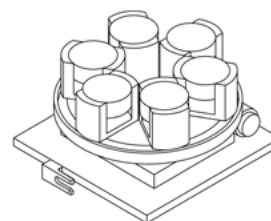

Trace Mapping Analysis

Trace functions can be added to standard mapping analysis. For samples with surface irregularities or inclination, when the height changes as a function of the X-Y position, the sample's Z axis height can be corrected, enabling high-accuracy mapping analysis in which reductions in signal intensity are minimized. This feature is achieved by minutely controlling the stage's Z axis coordinates during the analysis, based on height data obtained beforehand from multiple points. The trace surface found from the configured height data can be confirmed via contour lines and 3D displays.

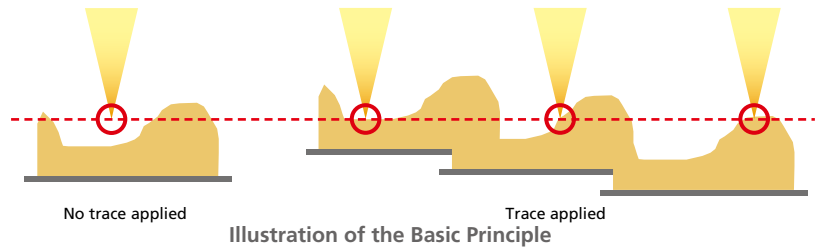
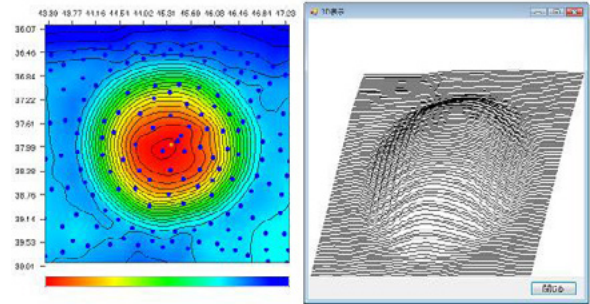

● Mapping Analysis Results

Example of a sample 20 cent coin: Cu mapping



Topographical image

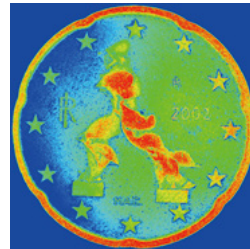

No trace applied

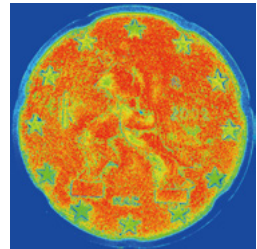

Trace applied

A more correct elemental distribution is obtained by using the trace.

* The trace is centered on the figure and periphery. The stars and the border are not targeted.

Trace Line Analysis

As with trace mapping analysis, trace functions can be added to a standard line analysis.

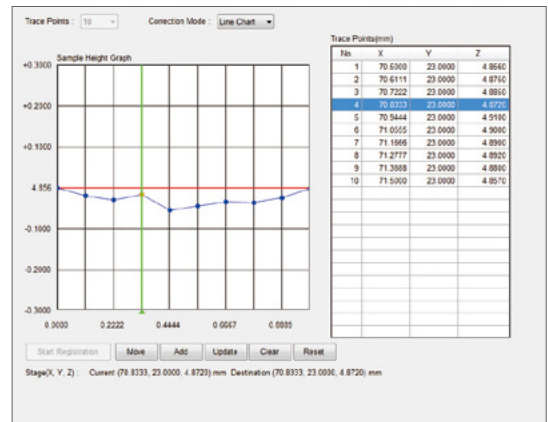

Phase Analysis

A scatter diagram is created with the 2D or 3D correlations obtained from mapping data for each element. Regions featuring a particular relationship between elements are displayed in different colors. In addition, multiple scatter diagrams can be displayed simultaneously, enabling the observation of correlations between multiple elements.

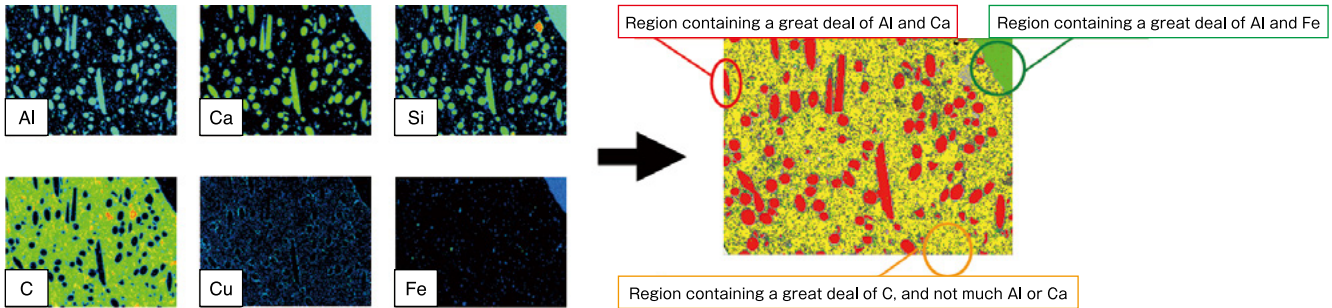

● Features

By creating a 3D image of the scatter diagrams, it is possible to observe the correlation from a variety of observation points.

Multiple correlations can be analyzed while switching between elements and scatter diagrams.

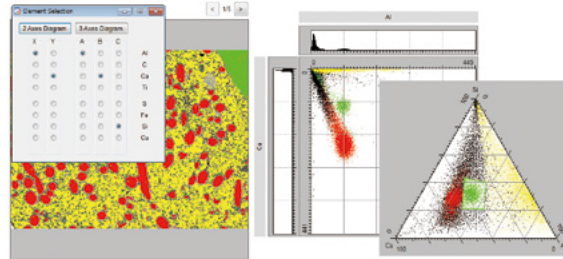
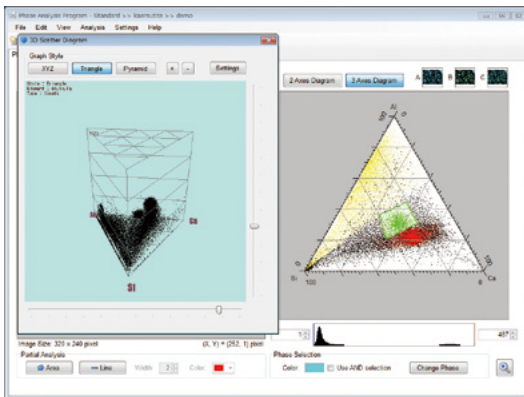

Electron Penetration Simulator

It is possible to simulate the analysis depth and width of the irradiating electron beam penetrated from the surface of the sample. The X-ray penetration domain can be calculated by using either the electron range method, with which the electron beam diffusion size and the analysis domain are found, or the Monte Carlo method, which follows individual electron trajectories to obtain the total electron trajectory (penetration domain).

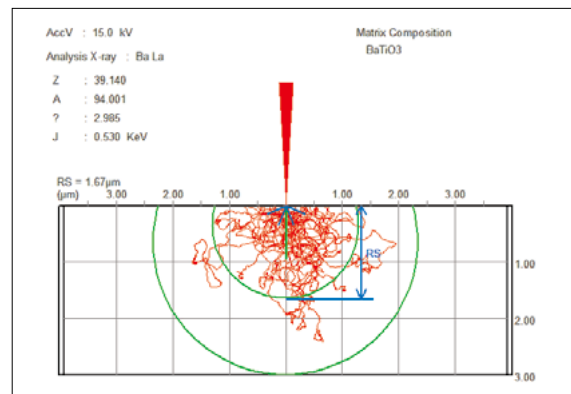

Other Options

- EPMA Spectra Collection

This qualitative spectral data collection consists of actual measurements of 76 elements including metallic compounds and standard compound samples. When difficult determinations are needed in qualitative analyses of samples containing complicated elements and trace elements, results can be confirmed through comparison with actual spectral peaks.

- External PC Software

This software enables the same type of data processing on an external PC as on the EPMA host PC. By connecting with the host PC over a network, not only can you review acquired data in the host PC, but you can also download the data for analysis or upload analyzed data to the host PC.

- Air Compressor

The EPMA-1720 Series uses separate compressed air sources to drive the air valves and air dampers.

- Cooling Water Circulation Unit

The excellent cooling water circulation unit used to cool the electron optical system in the EPMA-1720 Series is a low-vibration, stable-temperature model.

Special Accessories (By Separate Arrangement)

- Sample Holders
- Large Specimen Stage (L Stage)
- Cathodoluminescence Spectrometer
- X-Ray Generation Indicator Lamp
- Interface (for energy dispersive X-ray spectrometer)
- Emergency Machinery Stop Button

Specifications

	EPMA-1720T	EPMA-1720HT
Electron Optical System		
Electron Source	W (tungsten) filament	CeB ₆ cathode (W filament is also available.)
Secondary-Electron Image Resolution	6 nm	5 nm
Accelerating Voltage	0.1 kV to 30 kV (in 0.1 kV increments: up to 5 kV setting is possible in 10 V units)	
Beam Current	1 pA to 1 μA	
Magnification	40× to 400,000×	
Back-Scattered Electron Detector	4-block, semiconductor detector	
Objective Aperture	Fixed type (No selection required)	
Observation Optical System		
Resolution	1 μm (for observation with the naked eye)	
Field of View	Approx. 600 μm dia. (for observation with the naked eye), approx. 480 μm × 360 μm (on a computer screen)	
Subject Depth	4 μm	
Sample Stage System		
Maximum Sample Dimension	100 mm × 100 mm × 50 mm [†]	
Maximum Sample Weight	2 kg	
Maximum Stage Drive Range	X, Y: 90 mm Z: 7 mm	
Minimum Feed Distance	X, Y: 0.02 μm Z: 0.1 μm	
Maximum Stage Drive Speed	X, Y: 15 mm/sec Z: 1 mm/sec	
X-Ray Spectrometer System		
Analyte Elements Range	₄Be to ₉₂U	
Number of X-Ray Spectrometers	2 to 5 channels	
X-Ray Take-Off Angle	52.5°	
Rowland Circle Radius	4 inch (101.6 mm)	
Evacuation System		
Vacuum Level	Analysis Chamber	1.0 × 10 ⁻³ or less
	Electron-Gun Assembly	—
		2.0 × 10 ⁻⁵ Pa or less
Evacuation Pump	Main Evacuation	1 turbomolecular pump and 1 oil rotary pump
	Preliminary Evacuation	1 oil rotary pump
	Electron-Gun Evacuation	—
		1 ion pump
Vacuum Detection	Penning gauge, Pirani gauge	
Automated Functions	Automatic evacuation (main chamber evacuation, shut-down, sample loading chamber evacuation, electron gun chamber evacuation), automatic baking (EPMA-1720HT only)	
Computer System		
PC	Windows® 10 Pro (64 bit), main memory 8 GB or greater, HDD 1 TB or greater	
Display	23-inch LCD (1920 × 1080)	
Analysis Software		
Analysis Mode	Qualitative analysis, mapping analysis, quantitative analysis, calibration curve analysis, state analysis, line analysis	
Automated Analysis	Auto sequence analysis, easy mode analysis	
Operation Support	Data browser, report function, instrument monitor	
Management Functions	Environment set-up program	
Observation Software		
Control Functions	Electron optical system control, observation system control, sample stage control, X-ray spectrometer control, evacuation system control	
Automated functions	Auto focus, auto stigma, auto contrast/brightness, filament automatic saturation, automatic beam current settings	

Installation Requirements

Installation Requirements for EPMA-1720 Series

(Refer to the separate Pre-Installation Requirements for details.)

Ambient Conditions	• Temperature	18 °C to 28 °C (Provide an air conditioning system to control temperature fluctuation within ± 1 °C.)	
	• Humidity	30%RH to 60%RH	
	• Heat Generation Rate	When used with natural cooling water discharged: Approx. 2.1 kW When used with cooling water circulation unit: Approx. 2.9 kW (including heat generated by that unit)	
Installation Room	• Floor Area	W 4.5 m min. x D 3 m min. x H 2.5 m min.	
	• Door	Width: 1.25 m min., height: 1.8 m min.	
Power Requirements	• Analyzer	Single phase 200 V AC $\pm 10\%$, 30 A, 50/60 Hz, 1 circuit	
	• PC	Single phase 100 to 240 V AC $\pm 10\%$, 5 A, 50/60 Hz, 1 circuit	
Grounding Resistance	• 100 Ω max.		
Cooling Water	• Water Supply	Water pressure: 0.08 MPa to 0.18 MPa Water temperature: 20 °C to 25 °C	Flow rate: 0.7 L/min min. Faucet outer diameter: 11 mm
	• Water Drainage	Natural drainage (same height as floor)	
Gas	• PR Gas	Mixture of Ar (Argon) + CH ₄ (Methane) 10 vol % Pressure: 1 kPa to 3 kPa Flow rate: 10 mL/min to 14 mL/min Connection port: Connect a gas cylinder filled to the following specifications. Gas filling pressure: 15 MPa max. Cylinder port: W22 - 14 right-handed male screw	
	• Compressed Air	Pressure: 0.45 MPa to 0.6 MPa Connection port: Rc 1/4	
	• Dry Nitrogen Gas (EPMA-1720HT only. Recommended for purging electron gun when using CeB ₆ .)	Pressure: 0.08 MPa to 0.1 MPa Connection port: Joint for tube with 6 mm diameter	
Vibration and Stray Magnetic Fields	Indicated in the Pre-Installation Requirements. For more information, contact your Shimadzu representative.		
Laws and Regulations	To prevent X-ray radiation accidents, safety regulations and standards for devices equipped with X-ray generators have been established in each country. Observe the laws and regulations for X-ray generators that are applicable in the country where the product is used. For notifications on installation and safety controls, follow the necessary procedures in compliance with the laws and regulations applicable in the country where the product is used. (1) Rated output: 30 kV, 0.2 mA max. (2) Dose rate: 1 μ Sv/h or less		

Layout Example

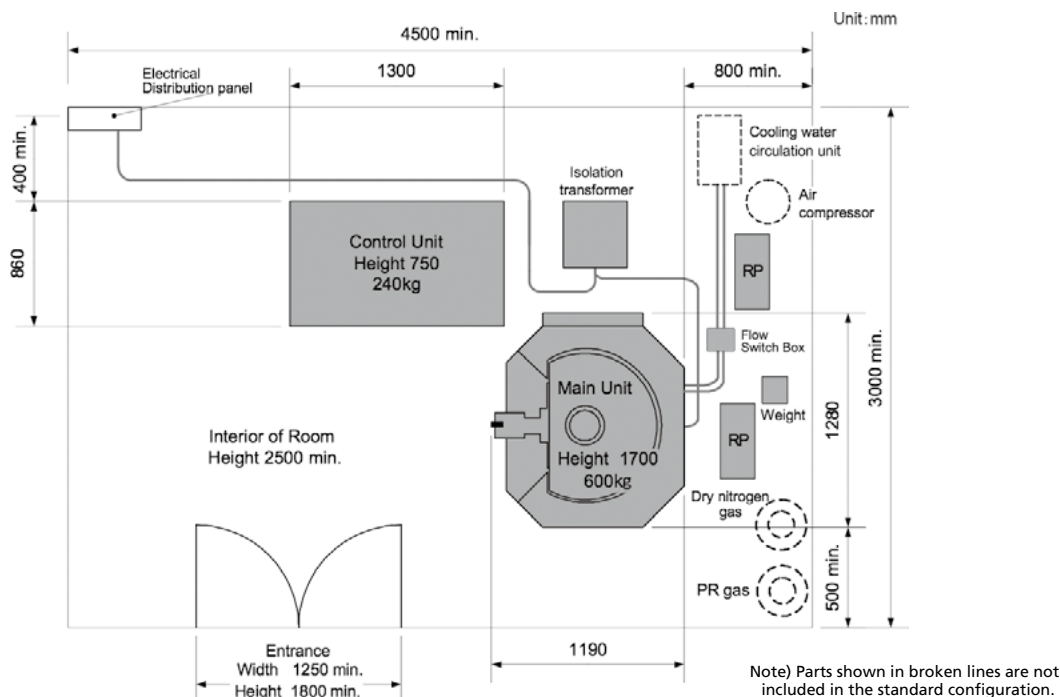

Windows is either a registered trademark or a trademark of Microsoft Corporation in the United States and/or other countries.



Shimadzu Corporation
www.shimadzu.com/an/

For Research Use Only. Not for use in diagnostic procedures.

This publication may contain references to products that are not available in your country. Please contact us to check the availability of these products in your country.

Company names, products/service names and logos used in this publication are trademarks and trade names of Shimadzu Corporation, its subsidiaries or its affiliates, whether or not they are used with trademark symbol "TM" or "®".

Third-party trademarks and trade names may be used in this publication to refer to either the entities or their products/services, whether or not they are used with trademark symbol "TM" or "®".

Shimadzu disclaims any proprietary interest in trademarks and trade names other than its own.

The contents of this publication are provided to you "as is" without warranty of any kind, and are subject to change without notice. Shimadzu does not assume any responsibility or liability for any damage, whether direct or indirect, relating to the use of this publication.